

ANBAUANLEITUNG

mounting instructions • instructions de montage • instrucciones de montaje • istruzioni di montaggio

GPT.05.845.70000/S

beinhaltet • contains • contient • contiene • contiene

GPT.05.845.19000/B

GPT.00.152.35100/B

ALK.00.733.15000/S

ALK.00.165.16503

Numero di articolo: GPT.05.845.19000/B

Revisione: 01 · Data: 07 - 2023

Portabagagli ADVENTURE-RACK

 ~ 0.75 h.

 FACILE      DIFFICILE

ITALIANO -Grazie per aver scelto questo prodotto premium di SW-MOTECH. Visita il nostro negozio online per ulteriori informazioni (ad es. per la compatibilità con i vari modelli). I documenti richiesti (ad es. certificato di omologazione nazionale) possono essere scaricati qui.

Si prega di leggere attentamente le avvertenze di sicurezza e le istruzioni per il montaggio prima di montare e utilizzare il prodotto, al fine di evitare eventuali lesioni e danni. Conserva queste istruzioni per il montaggio come riferimento futuro.

Questo prodotto è stato sviluppato per veicoli in condizioni di fabbrica. La compatibilità con gli accessori originali o di altri produttori non può essere garantita.

Queste istruzioni per il montaggio sono state redatte in base alle nostre conoscenze attuali. Non sussistono pretese di correttezza giuridiche. Salvo errori ed omissioni. Ci riserviamo il diritto di apportare modifiche tecniche e di design. Copyright SW-MOTECH.

SIMBOLO DI SICUREZZA

 Questo simbolo di avvertenza è usato nelle presenti istruzioni di montaggio per segnalare pericoli mortali, rischio di lesioni o altri pericoli. Le parole "PERICOLO", "AVVERTENZA" O "ATTENZIONE" sono utilizzate con questo simbolo di avvertenza per trasmettere importanti istruzioni di sicurezza e informazioni relative al montaggio e all'uso di questo prodotto. Queste parole, utilizzate insieme al simbolo di avvertenza, significano:

 **PERICOLO:** indica una situazione di pericolo che, se non evitata, può causare morte o lesioni gravi!

 **AVVERTENZA:** indica una situazione di pericolo che, se non evitata, può causare morte o lesioni gravi!

 **ATTENZIONE:** indica una situazione di pericolo che, se non evitata, può provocare lesioni lievi o di entità moderata!

 **AVVISO:** indica informazioni importanti che non riguardano il rischio di morte o di lesioni (riguardano unicamente il rischio di danni materiali)!

INFORMAZIONI GENERALI

 **AVVERTENZA:** il montaggio e/o la manutenzione di questo prodotto richiedono competenze tecniche avanzate, strumenti adeguati e una buona conoscenza dell'uso della strumentazione e delle indicazioni relative alle coppie di serraggio. Per ragioni di sicurezza, SW-MOTECH raccomanda di far eseguire il montaggio e/o la manutenzione presso un'officina per motociclette qualificata e certificata.

 **AVVERTENZA:** se si decide di installare questo prodotto in autonomia, leggere attentamente le istruzioni per il montaggio prima del montaggio e dell'uso e seguire tutte le avvertenze per evitare lesioni gravi o mortali. Durante il montaggio e l'uso, seguire anche tutte le istruzioni pertinenti contenute nel manuale del veicolo. **SE NON SI COMPRENDONO TALI ISTRUZIONI, ANCHE SOLO IN PARTE, O SE SONO NECESSARI CHIARIMENTI, NON CERCARE DI MONTARE IL PRODOTTO IN AUTONOMIA SENZA CHIEDERE IL SUPPORTO DI SW-MOTECH!**

PREPARAZIONE: leggere attentamente le istruzioni per il montaggio e assicurarsi che siano disponibili tutti i componenti contenuti nella lista.

 **ATTENZIONE:** assicurarsi che il veicolo sia perfettamente fermo. Spegner il motore e togliere la chiave. Se necessario, lasciar raffreddare il motore/lo scarico. Scollegare la batteria quando si interviene sull'impianto elettrico. Usare esclusivamente strumenti idonei e indossare sempre occhiali e guanti protettivi durante le operazioni di montaggio e manutenzione. Chiedere aiuto a una seconda persona durante le fasi di montaggio e manutenzione.

MONTAGGIO: tutti i componenti e i collegamenti rimossi dal veicolo devono essere reinstallati secondo le specifiche del produttore del veicolo o sostituiti con componenti e attrezzatura forniti da SW-MOTECH.

 **AVVERTENZA:** fissare tutte le filettature con frenafili liquido a media resistenza, se non diversamente specificato.

 **PERICOLO:** le coppie di serraggio non definite da SW-MOTECH devono essere richieste al costruttore del veicolo o a un'officina certificata.

CONTROLLO DI FUNZIONALITÀ: dopo il montaggio accertarsi che non vi siano parti mobili bloccate e che il funzionamento del veicolo non sia compromesso. I cavi e i tubi flessibili non devono sfregare e/o essere schiacciati.

 **AVVERTENZA:** eseguire un controllo completo delle funzioni prima di mettersi alla guida. Controllare la coppia di serraggio di tutti i collegamenti e la tenuta del prodotto dopo i primi 50 km e in seguito regolarmente. Gli accessori montati possono modificare la maneggevolezza e la stabilità del veicolo.



SW-MOTECH GmbH & Co. KG
Ernteweg 7-10
35282 Rauschenberg
Germania



info@sw-motech.com
www.sw-motech.com



Consultare i simboli e il loro significato nella sezione MONTAGGIO. Se nella sezione montaggio compare la sigla OEM, è necessario rispettare e applicare le specifiche del produttore del veicolo.



Per qualsiasi domanda, non esitare a contattare il nostro servizio clienti o i nostri distributori. Il nostro numero di telefono e l'elenco dei nostri distributori sono disponibili nel nostro negozio online:

www.sw-motech.com



Usare un frenafiletto: indica che la filettatura deve essere rivestita con un frenafiletto liquido. H (ALTA): alta resistenza; M (MEDIA): media resistenza; L (BASSO): bassa resistenza.











































Serraggio / rispetto delle specifiche sulla coppia di serraggio: indica la coppia di serraggio di un componente specificata da SW-MOTECH o dal produttore del veicolo (OEM).



Non utilizzare il frenafiletto: segnala di non dover utilizzare il frenafiletto liquido in quel determinato punto.

ELENCO DELLE PARTI - LEGGI E CONSERVA LE ISTRUZIONI DI MONTAGGIO!

<p>2</p> <p>1</p>  <p>GPT.05.845.901.01.11</p> <p> 1/1</p>	<p>2</p>  <p>GPT.05.845.902.01.11</p> <p> 1/1</p>	<p>3</p>  <p>M6 x 16; ISO 7380 SC.ST.06.016.01.7380.109</p> <p> 2/2</p>	<p>4</p>  <p>M8 x 20; DIN 912 SC.ST.08.020.01.912.088</p> <p> 2/2</p>	<p>5</p>  <p>ø 8,4; DIN 9021 US.ST.084.01.9021.300</p> <p> 2/2</p>	<p>6</p>  <p>KES.RD.210.0300.02.GL</p> <p> 2/2</p>
<p>3</p> <p>7</p>  <p>M8 x 40; ISO 7380 SC.ST.08.040.02.7380.109</p> <p> 2/2</p>	<p>8</p>  <p>ø 8,4; DIN 9021 US.ST.084.02.9021</p> <p> 2/2</p>	<p>9</p>  <p>Ø 25 / Ø 8,4 / h 5 DB.ST.0250.0084.0050.02</p> <p> 2/4</p>	<p>10</p>  <p>Ø 30 / ø 10,5 / h 5 DB.ST.0300.0105.0050.02</p> <p> 2/2</p>		
<p>4</p> <p>11</p>  <p>GPT.05.845.001.11</p> <p> 1/1</p>	<p>12</p>  <p>M8 x 70; DIN 7991 SC.ST.08.070.02.7991.088</p> <p> 2/2</p>	<p>13</p>  <p>Ø 25 / ø 8,4 / h 25 DB.ST.0250.0084.0250.02</p> <p> 2/2</p>	<p>14</p>  <p>M8 x 55; DIN 7991 SC.ST.08.055.02.7991.088</p> <p> 2/2</p>	<p>15</p>  <p>Ø 25 / Ø 8,4 / h 5 DB.ST.0250.0084.0050.02</p> <p> 2/4</p>	<p>16</p>  <p>Ø 12 / ø 8,4 / h 28 DB.00.120.084.028.01</p> <p> 2/2</p>
<p>17</p>  <p>M8; DIN 6927 MU.ST.08.02.6927.08</p> <p> 2/2</p>					
<p>5</p> <p>18</p>  <p>GPT.00.152.002.11</p> <p> 1/1</p>	<p>19</p>  <p>M6 x 18; ISO 7380 SC.ST.06.018.02.7380.109</p> <p> 4/4</p>	<p>20</p>  <p>ø 6,4; DIN 9021 US.ST.064.02.9021</p> <p> 4/4</p>			

1

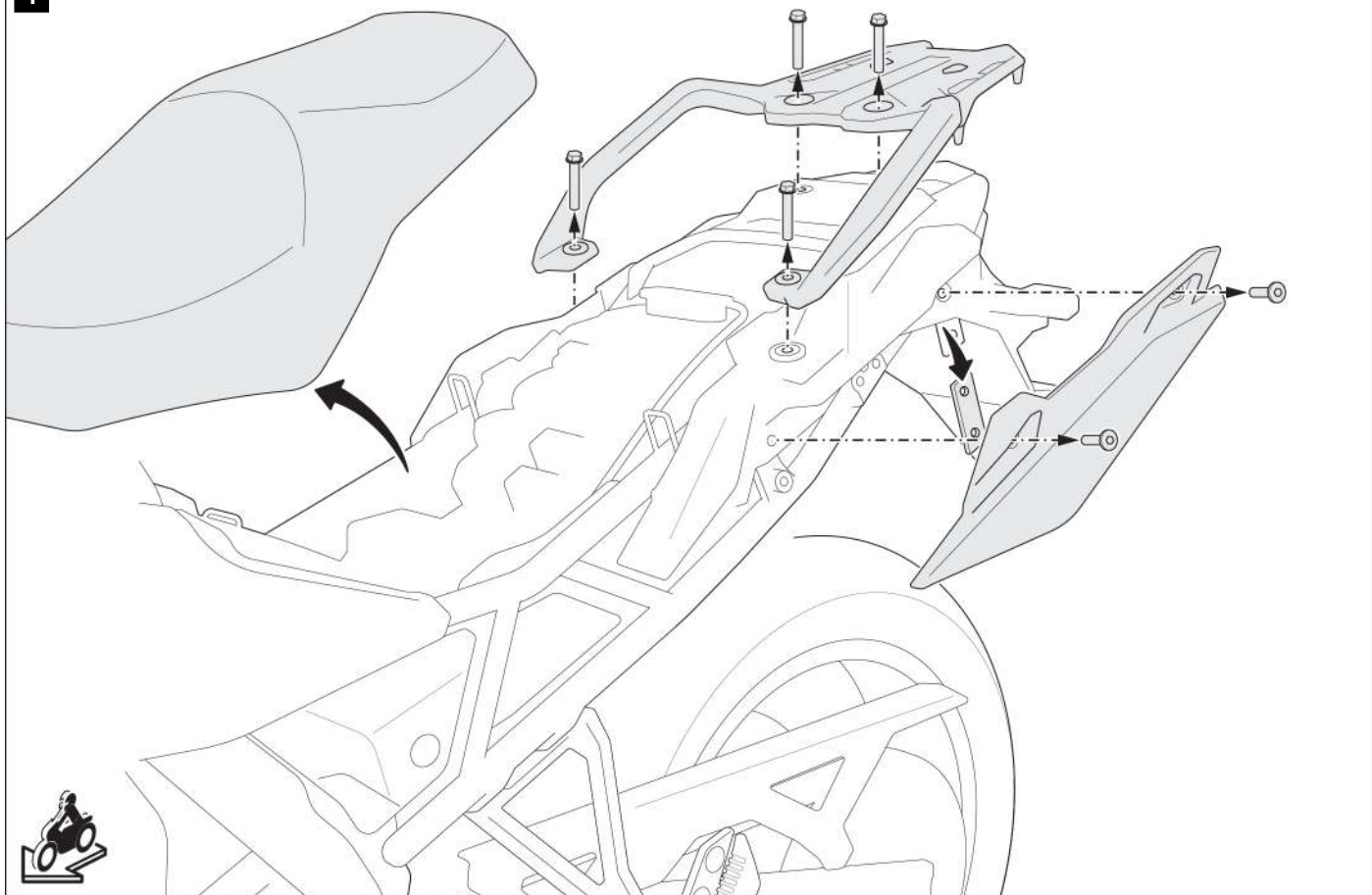

- ▲ **AVVERTENZA: indossare sempre le protezioni per gli occhi e le mani!**
- ▲ **AVVERTENZA: utilizzare sempre strumenti adeguati!**

Rimuovere la sella dal veicolo seguendo le istruzioni del manuale del produttore.

Allentare le viti indicate e rimuovere il portabagagli, le parti della carenatura e i distanziali indicati su entrambi i lati.

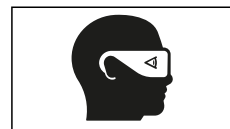

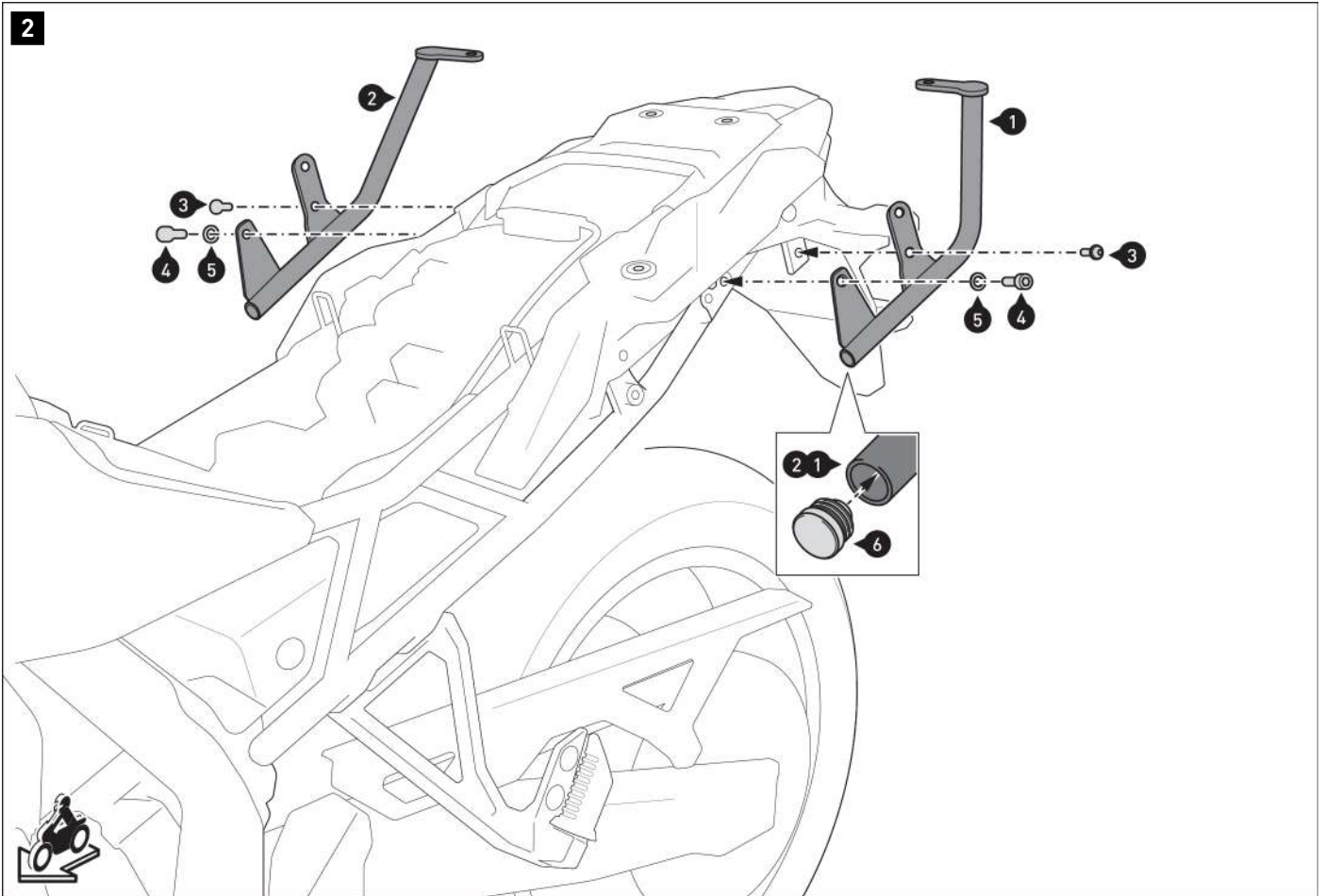

Inserire i tappi di plastica (6) nelle aperture dei telai laterali su entrambi i lati.

Avvitare i telai laterali (1) e (2) al veicolo.

⚠ AVVERTENZA: Usare un frenafiletto liquido!
Non serrare ancora le viti.

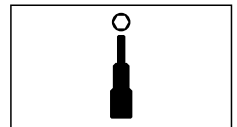
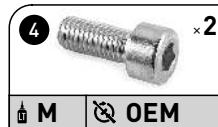

3

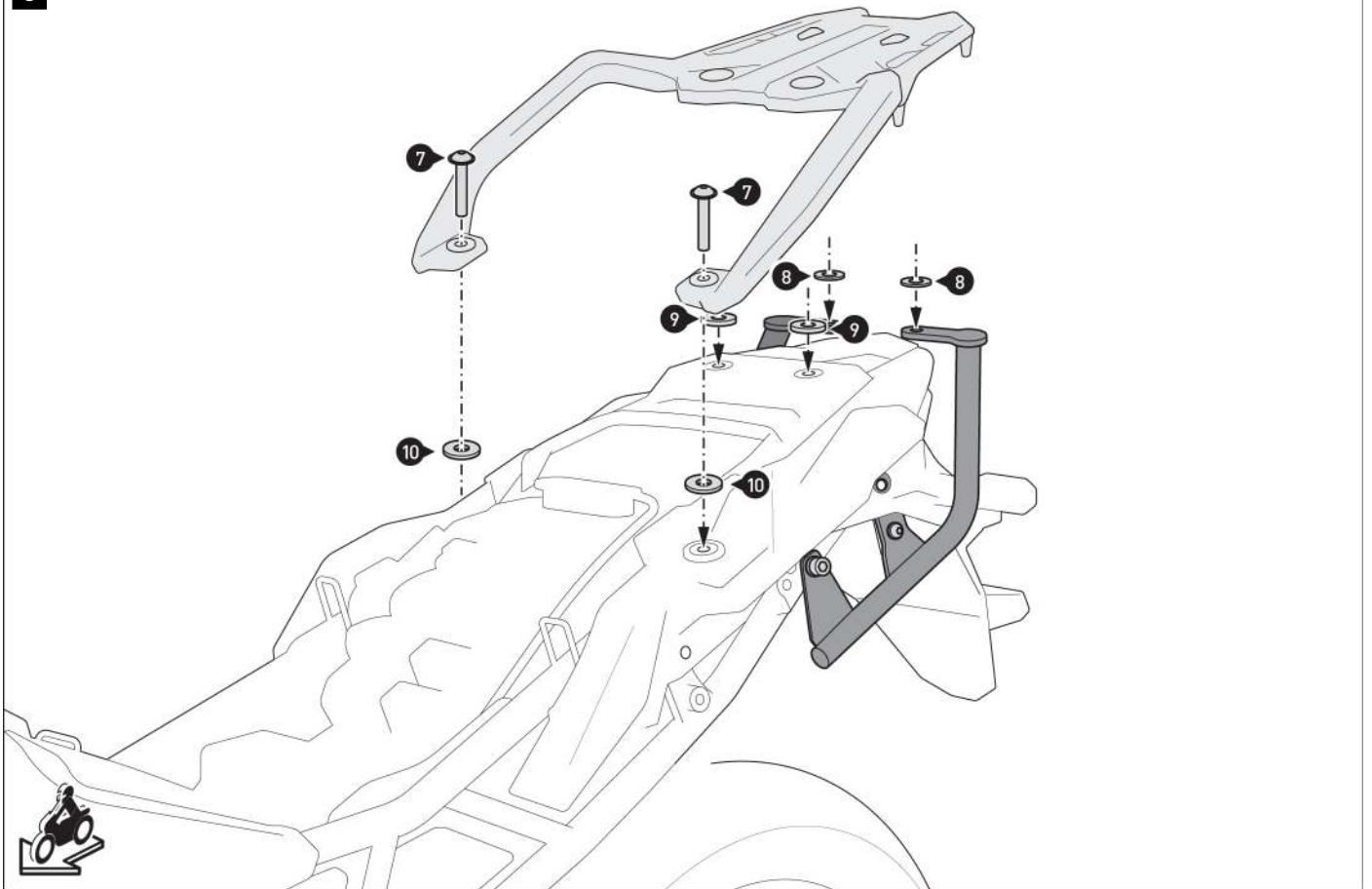

⚠ AVVISIO: al momento del collegamento con il telaio laterale SW-MOTECH, i distanziali (9) e (10) non sono necessari. Al loro posto, montare il telaio laterale insieme alle parti del portabagagli.

Riavvitare il portabagagli originale al veicolo.

⚠ AVVERTENZA: Usare un frenafiletto liquido!
Non serrare ancora le viti.

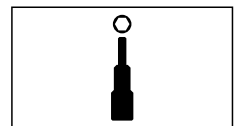

4

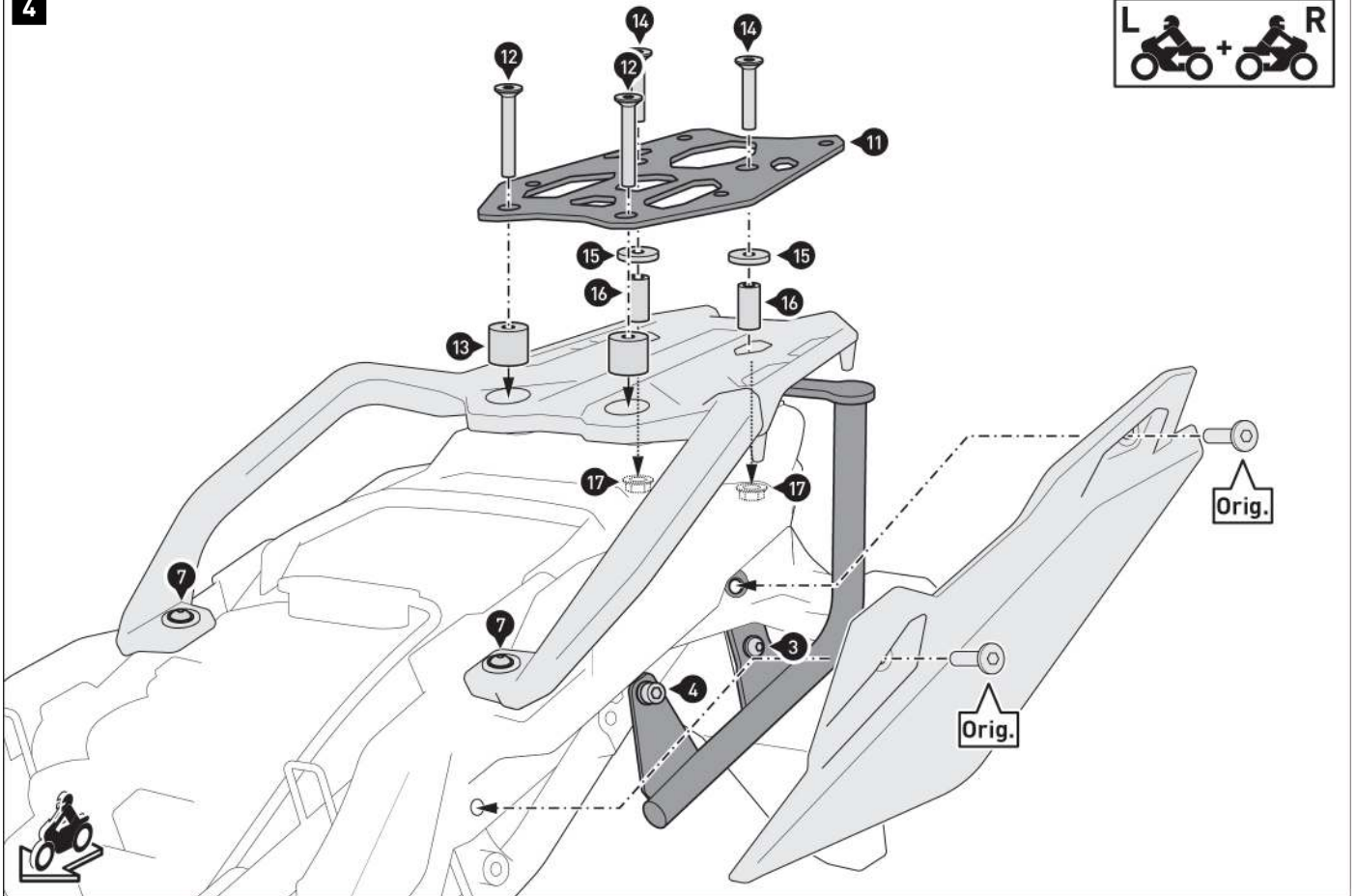
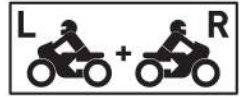

Avvitare la piastra adattatrice [11] al portabagagli originale.
▲ AVVERTENZA: per le viti (12), utilizzare un frenafiletto liquido!
 Quando tutti i componenti saranno privi di tensione, serrare le viti (3), (4), (7) e (12) seguendo le istruzioni fornite dal produttore.
 Serrare le viti (14) come specificato nelle istruzioni per il montaggio.

Riavvitare i pannelli laterali al veicolo.
▲ AVVERTENZA: Usare un frenafiletto liquido!
 Avvitare le viti originali (Orig.) secondo le istruzioni del produttore.

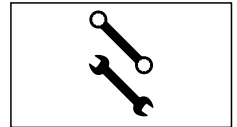
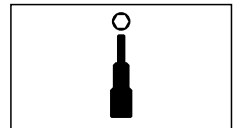
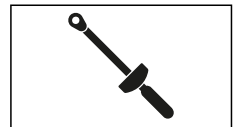

5

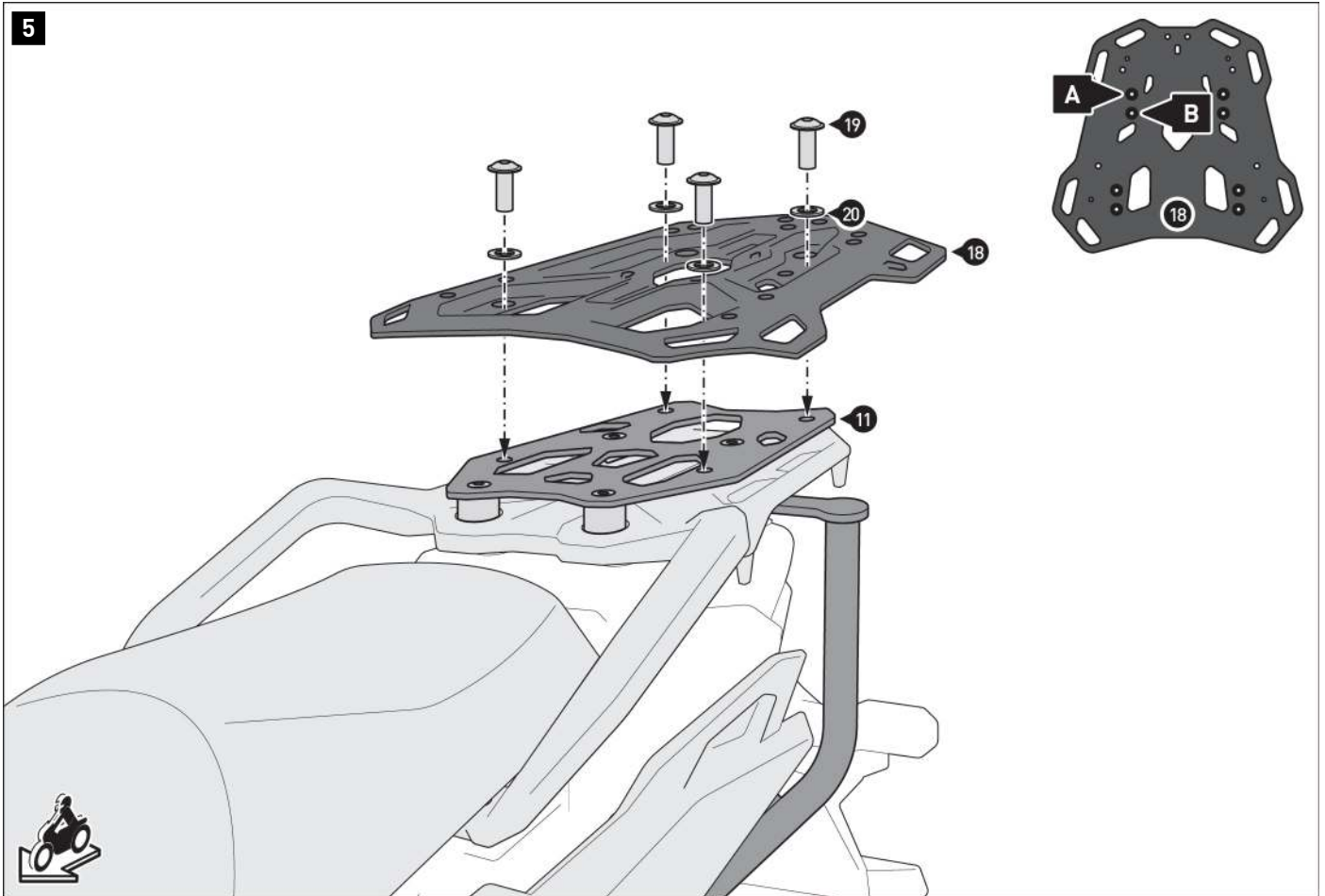

⚠ AVVISO: evitare il portabagagli nella posizione di montaggio contrassegnata con (A) o (B), a seconda dello spazio disponibile, come indicato nel disegno dettagliato.

Montare il portabagagli (18) sulla piastra adattatrice (11).

⚠ AVVERTENZA: Usare un frenafilietti liquido!

Serrare le viti come indicato nelle istruzioni per il montaggio.



M 10 Nm

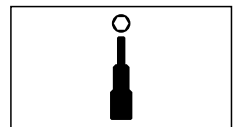
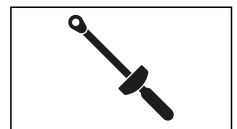

AVVERTENZE SPECIFICHE DEL PRODOTTO

⚠ AVVERTENZA: il carico massimo specificato comprende il peso della valigia/bagaglio e della piastra di adattamento/kit adattatore! Si applica il carico massimo del veicolo specificato dal costruttore del veicolo!



≤ 10 kg (≤ 22 lbs)



≤ 130 km/h (≤ 80 mph)

⚠ AVVISO: rispettare le normative specifiche del paese per l'immatricolazione/l'uso del veicolo, come le normative TÜV applicabili. Dopo il montaggio, far inserire le parti soggette a omologazione nei documenti del veicolo dal proprio centro di test.

Art.-Nr. / Item No.: GPT.00.152.35100/B

Revision: 00 · Datum / Date: 01 - 2018

**Adapterkit für ADVENTURE-/STREET-RACK
Gepäckträger – TRAX****Adapter kit for ADVENTURE-/STREET-RACK
– TRAX**

DEUTSCH - Vielen Dank, dass Sie sich für dieses Premium-Produkt von SW-MOTECH entschieden haben. Bitte besuchen Sie unseren Webshop für weitere Informationen wie Modellzuweisungen und PDF-Anbauanleitung. Erforderliche Dokumente (z. B. ABE) stehen als Download zur Verfügung.

Die Montage und/oder Wartung dieses Produkts erfordert ein gutes technisches Verständnis! Zu Ihrer eigenen Sicherheit empfiehlt SW-MOTECH, die Montage und/oder Wartung durch eine Fachwerkstatt durchführen zu lassen! SW-MOTECH übernimmt keine Haftung für Schäden, die durch eine unsachgemäße Montage und/oder Wartung verursacht wurden!

Beachten Sie alle in der Anbauanleitung angegebenen Hinweise und die für die Montage relevanten Informationen im Fahrzeughandbuch. Nichtbeachtung kann zu Schäden am Fahrzeug bzw. zur Gefährdung des Fahrers führen! Diese Anbauanleitung ist nach unserem derzeitigen Kenntnisstand verfasst worden. Rechtliche Ansprüche auf Richtigkeit bestehen nicht.

Dieses Produkt wurde für Fahrzeuge im Werkzustand entwickelt. Die Kompatibilität mit Original-Zubehörteilen bzw. den Zubehörteilen anderer Hersteller kann nicht gewährleistet werden. Stellen Sie des Weiteren VOR Montage dieses Produkts sicher, dass sich alle beweglichen Teile (z. B. die Kette) im ursprünglichen Wartungszustand befinden. Montiertes Zubehör kann das Fahrverhalten und/oder die Stabilität Ihres Fahrzeugs verändern.

ALLGEMEINE HINWEISE

Beachten Sie die landesspezifischen Vorschriften für Zulassung/Betrieb Ihres Fahrzeugs bzw. anwendbare TÜV-Vorschriften. Lassen Sie eintragungspflichtige Teile nach Montage durch Ihre Prüfstelle in die Fahrzeugpapiere eintragen.

VORBEREITUNG: Lesen Sie die Anbauanleitung aufmerksam und stellen Sie sicher, dass alle Teile der Stückliste vorhanden sind. Achten Sie darauf, dass Ihr Fahrzeug sicher steht und nicht umfallen kann. Schalten Sie den Motor ab und ziehen Sie den Zündschlüssel. Lassen Sie ggf. den Motor/Auspuff abkühlen. Klemmen Sie bei Arbeiten an der Elektrik die Fahrzeugbatterie ab. Verwenden Sie geeignetes Werkzeug. Lassen Sie sich von einer zweiten Person helfen.

MONTAGE: Alle vom Motorrad gelösten Teile und Verbindungen sind gemäß den Fahrzeugherstellereangaben wieder zu montieren oder durch die von SW-MOTECH gelieferten Teile zu ersetzen. Sichern Sie, falls nicht anderweitig definiert, alle Gewinde mit mittelfester, flüssiger Schraubensicherung.

Alle nicht durch SW-MOTECH definierten Anzugsmoment-Vorgaben müssen beim Fahrzeughersteller oder einer Fachwerkstatt erfragt werden!

FUNKTIONSKONTROLLE: Stellen Sie nach der Montage sicher, dass alle zuvor gelösten Teile und Verbindungen wieder ordnungsgemäß montiert wurden. Achten Sie außerdem auf die uneingeschränkte Freigängigkeit und einwandfreie Funktion sämtlicher Fahrzeugteile. Kabel, Züge und Schläuche dürfen nicht scheuern und/oder geklemmt werden. Führen Sie vor Fahrtbeginn eine umfassende Funktionskontrolle durch. Überprüfen Sie nach den ersten 50 km und anschließend in regelmäßigen Abständen das Anzugsmoment aller Schraubverbindungen und den ordnungsgemäßen Sitz des Produkts.

ENGLISH - Thank you for choosing this premium product from SW-MOTECH. Please visit our webshop for additional information, such as application charts and PDF mounting instructions. Any other documents that may be required (e.g. ABE certifications), are also available for download at our webshop.

Installation and/or maintenance of this product require good technical understanding! For your own safety SW-MOTECH recommends having installation and/or servicing carried out by a specialist workshop! SW-MOTECH assumes no liability for damage caused by improper installation and/or maintenance work!

Carefully follow all the directions given in the mounting instructions and pay attention to all relevant information in the vehicle manual during assembly. Nonconformance can lead to vehicle damage or even endanger the driver! These mounting instructions are written based on our current state of knowledge. Legal requirements for accuracy do not exist.

This product was developed for vehicles in their factory setting. Compatibility with original accessory parts or other manufacturers' accessory parts is not guaranteed. Furthermore, BEFORE installing this product, make sure that all moving parts (e.g. the chain) are in the original state of maintenance. Installed accessories can change the driving behaviour and/or stability of your vehicle.

GENERAL INFORMATION

Observe the country-specific regulations concerning vehicle registration/operation as well as TÜV regulations if applicable. If required, register installed parts in the vehicle documents through an appropriate inspection authority.

PREPARATION: Read the mounting instructions carefully and make sure that all items of the parts list are included. Make sure that your vehicle is parked safely and cannot fall over. Turn off the engine and remove the ignition key. Let the motor/exhaust cool off if necessary. Disconnect the vehicle battery when working on the electrical system. Use appropriate tools. Have another person to help you.

MOUNTING: All parts and connections removed from the vehicle must be reinstalled in accordance with the vehicle manufacturers' specifications or replaced by parts delivered by SW-MOTECH. Secure all threads, unless otherwise specified, with medium-strength liquid thread locker.

Torque specifications undefined by SW-MOTECH must be obtained from the vehicle manufacturer or by a specialist workshop!

FUNCTION CHECK: After installation make sure that all parts and connections previously removed are properly replaced. Also make sure that no moving parts are obstructed and no function of the vehicle is hindered in any way. Cables and hoses must not rub and/or be pinched. Before starting to ride, perform a comprehensive check of all functions. After the first 50 km and then at regular intervals, check the tightening torque of all screw connections and the proper fit of the product.

Konfektionierung durch / Packed by:

Datum der Konfektionierung / Date of packaging:



SW-MOTECH GmbH & Co. KG

Ernteweg 8/10
35282 Rauschenberg
GermanyTel. / phone + 49 (0)6425 / 8168 - 050
Fax / fax + 49 (0)6425 / 8168 - 10info@sw-motech.com
www.sw-motech.com

STÜCKLISTE / PARTS LIST

Schritt Step	Nr. No.	Art.-Nr. / Bezeichnung * Item No. / Description *	Artikel	Part	Anzahl ** Quantity **	N-m ***
(1)		ALK.00.165.010	Vorspannwinkel	Latch Hook	1 / 1	
(2)		M6 x 16; ISO 7380	Linsenkopfschraube	Lenshead Screw	2 / 2	9
(3)		M6; DIN 6927	Mutter mit Bund, selbstsichernd	Lock Nut with Flange	2 / 2	
(4)		ALK.00.165.083	Führungsbolzen	Guide Bolt	4 / 4	
(5)		ALK.00.165.084	Kunststoffkappe	Plastic Cap	4 / 4	
(6)		M6 x 20; DIN 7991	Senkkopfschraube; schwarz	Countersunk Screw; black	4 / 4	7
(7)		M6; DIN 985	Mutter, selbstsichernd	Lock Nut	4 / 4	

8.8	Regelgewinde / Coarse Thread Ø	M4	M5	M6	M8	M10	M12	10.9	Regelgewinde / Coarse Thread Ø	M4	M5	M6	M8	M10	M12
	Stahl FK 8.8 / Steel CL 8.8	N·m	2,8	5,5	9,6	23	46		79	Stahl FK 10.9 / Steel CL 10.9	N·m	4,1	8,1	14	34

* Alle Maßangaben in Millimeter. - ** Der zweite Wert gibt die Gesamtanzahl des jew. Artikels in der Lieferung an.
 *** **Keine Anzugsmomentvorgabe: Verwenden Sie das vom Fzg.-Hersteller definierte Anzugsmoment!** Das Standard-Anzugsmoment der Tabelle kann verwendet werden, wenn es den Fzg.-Hersteller-Vorgaben entspricht.

* All measurements in millimeters. - ** The second number indicates the total quantity of the part in the delivery.
 *** **No torque specifications: Use the torque defined by vehicle manufacturer!** The standard torque in this table can be used as long as it is within the vehicle manufacturer's specifications.



ADVENTURE-RACK Gepäckträger
ADVENTURE RACK

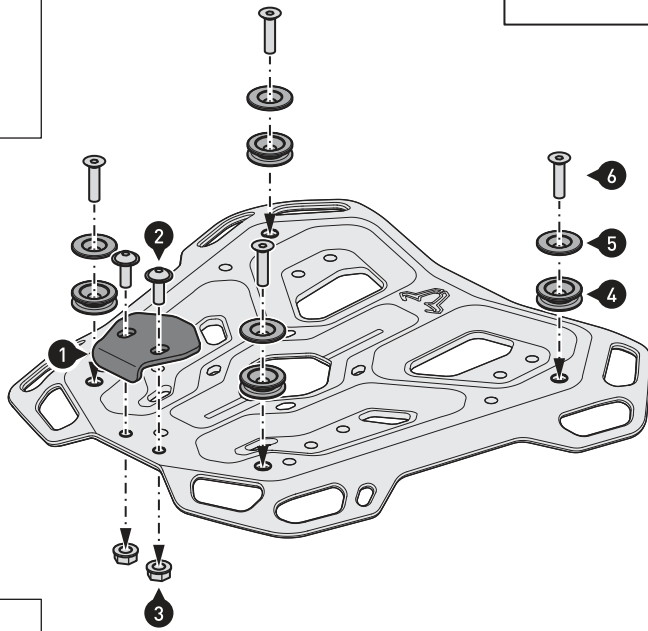
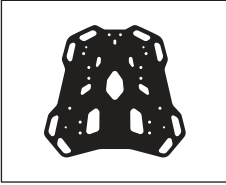

	9 N·m

ADVENTURE-RACK Gepäckträger
Verschrauben Sie die gezeigten Teile an ihrem ADVENTURE-RACK Gepäckträger (separat erhältlich).
ACHTUNG: Verwenden Sie flüssige Schraubensicherung (nur Schrauben (6))!
Ziehen Sie die Schrauben wie in der Stückliste vorgegeben an.

ACHTUNG: Um den sicheren Halt Ihres TRAX ADV/EVO/ION Topcase zu gewährleisten, justieren Sie den Vorspannwinkel (1) über die Langlöcher (siehe Detailzeichnung)! Achten Sie darauf, dass der Spannverschluss des Topcase bei Befestigung ordnungsgemäß greift!

ADVENTURE RACK

Attach the shown parts to your ADVENTURE RACK (sold separately).

ATTENTION: Use liquid thread locker (screws (6) only)!
Tighten the screws as specified in the parts list.

ATTENTION: To ensure the proper fit of your TRAX ADV/EVO/ION topcase, adjust the latch hook (1) over the elongated holes (see detail drawing)! Make sure that the topcase's latch engages properly when mounted!

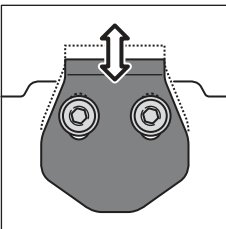

	7 N·m
	Medium

Adapterplatte für STREET-RACK
Adapter plate for STREET-RACK

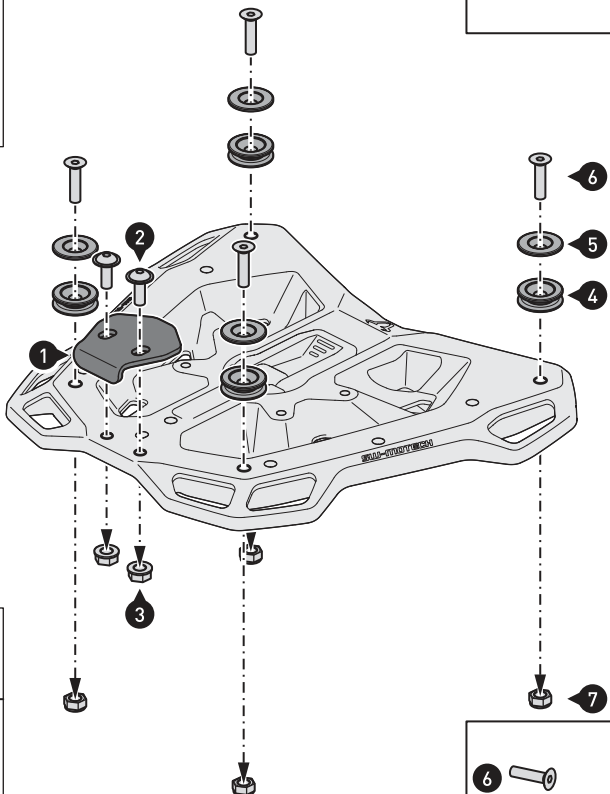
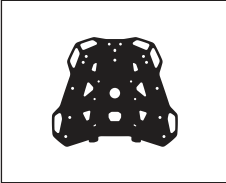

	9 N·m

Adapterplatte für STREET-RACK Gepäckträger

Verschrauben Sie die gezeigten Teile an ihrer Adapterplatte für STREET-RACK Gepäckträger (separat erhältlich).
Ziehen Sie die Schrauben wie in der Stückliste vorgegeben an.

ACHTUNG: Um den sicheren Halt Ihres TRAX ADV/EVO/ION Topcase zu gewährleisten, justieren Sie den Vorspannwinkel (1) über die Langlöcher (siehe Detailzeichnung)! Achten Sie darauf, dass der Spannverschluss des Topcase bei Befestigung ordnungsgemäß greift!

Adapter plate for STREET-RACK

Attach the shown parts to your adapter plate for STREET-RACK (sold separately).

Tighten the screws as specified in the parts list.

ATTENTION: To ensure the proper fit of your TRAX ADV/EVO/ION topcase, adjust the latch hook (1) over the elongated holes (see detail drawing)! Make sure that the topcase's latch engages properly when mounted!

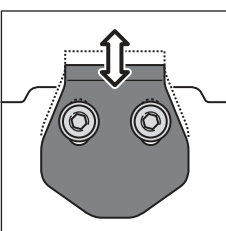

	7 N·m

TRAX ADVENTURE ALU-BOX

TRAX ADVENTURE ALU-BOX

DEUTSCH - Vielen Dank, dass Sie sich für dieses Qualitätsprodukt von SW-MOTECH entschieden haben.

☞ Bitte besuchen Sie unseren Webshop für weitere Informationen wie Modellzuweisungen und PDF-Anleitung. Erforderliche Dokumente (z. B. ABE) stehen als Download zur Verfügung. >> www.sw-motech.com

Die Montage und/oder Wartung dieses Produkts erfordert ein gutes technisches Verständnis. Zu Ihrer eigenen Sicherheit empfiehlt SW-MOTECH, die Montage und/oder Wartung durch eine Fachwerkstatt durchführen zu lassen. SW-MOTECH übernimmt keine Haftung für Schäden, die durch eine unsachgemäße Montage und/oder Wartung verursacht werden.

Beachten Sie unbedingt alle in der Anbauanleitung angegebenen Hinweise. Beachten Sie außerdem alle für die Montage relevanten Hinweise im Fahrzeughandbuch. Nichtbeachtung kann zu Schäden am Fahrzeug bzw. zur Gefährdung des Fahrers führen! Bitte heben Sie die Anbauanleitung als Referenz auf.

Dieses Produkt wurde für Fahrzeuge im Originalzustand entwickelt. Die Kompatibilität mit originalen Zubehörteilen bzw. den Zubehörteilen anderer Hersteller kann nicht gewährleistet werden. Montiertes Zubehör kann das Fahrverhalten und/oder die Stabilität Ihres Fahrzeugs verändern.

ALLGEMEINE HINWEISE

Beachten Sie eventuelle landesspezifische Vorschriften durch den Gesetzgeber bzw. TÜV-Vorschriften. Lassen Sie eintragungspflichtige Teile nach Montage durch Ihre Prüfstelle in die Fahrzeugpapiere eintragen.

SICHERHEIT

Bitte beachten Sie unbedingt die folgenden Hinweise zur TRAX ADVENTURE ALU-BOX:

Die TRAX ADVENTURE ALU-BOX wurde ausschließlich für die Montage an SW-MOTECH QUICK-LOCK Kofferträgern, der QUICK-LOCK Adapterplatte und dem STEEL-RACK Adapterkit entwickelt.

Manipulation oder Veränderungen am Kofferaufbau führen zum Ausschluss jeglicher Gewährleistungen.

ACHTUNG: Das Fahr-/Bremsverhalten des Motorrads verändert sich bei montierter TRAX ADVENTURE ALU-BOX merklich.

ACHTUNG: Benutzen Sie die TRAX ADVENTURE ALU-BOXEN M & L nur paarweise. Achten Sie dabei auf die gleichmäßige Verteilung der Ladung.

Max. Zuladung: siehe Anbauanleitung vom SW-MOTECH QUICK-LOCK Kofferträger, ALU-RACK oder STEEL-RACK. Höchstgeschwindigkeit mit montierten Koffern: 130 km/h.

ACHTUNG: Stellen Sie sicher, dass die TRAX ADVENTURE ALU-BOX korrekt am jeweiligen Adapter befestigt wird und an allen vier Befestigungspunkten einrastet! ALLE Spannverschlüsse der TRAX ADVENTURE ALU-BOX müssen VOR Fahrtbeginn mit dem separat erhältlichen TraX ® EVO / TRAX ADV Schließzylinder-Satz verschlossen werden und während der Fahrt verschlossen bleiben. Bei unsachgemäßer Befestigung besteht Verlustgefahr!

PFLEGE

Verwenden Sie zum Reinigen der TRAX ADVENTURE ALU-BOX warme Seifenlauge und ein weiches, sauberes Tuch. Spülen Sie anschließend mit klarem Wasser nach. Verwenden Sie KEINE scharfen Reinigungsmittel, raue Putzutensilien oder einen Hochdruckreiniger!

ENGLISH - Thank you for choosing this premium product from SW-MOTECH.

☞ Please visit our webshop for additional information, such as application charts and PDF mounting instructions. Any other documents that may be required (e.g. ABE certifications), are also available for download at our webshop. >> www.sw-motech.com

Installation and/or maintenance of this product require good technical understanding. For your own safety SW-MOTECH recommends having installation and/or servicing carried out by a specialist workshop. SW-MOTECH assumes no liability for damage caused by improper installation and/or maintenance work.

Carefully follow all the directions given in the mounting instructions. Also pay attention to all relevant information in the vehicle manual during assembly. Nonconformance can lead to vehicle damage or even endanger the driver! Please keep the mounting instructions as reference.

This product was developed for vehicles in their original condition. Compatibility with original accessory parts or other manufacturers accessory parts is not guaranteed. Installed accessories can change driving behaviour and/or stability of your vehicle.

GENERAL INFORMATION

Observe any country-specific legal or TÜV regulations. If required, enter the installed parts into the vehicle documents with the appropriate inspection authority.

SECURITY

Please pay attention to the following information concerning the TRAX ADVENTURE ALU-BOX:

The TRAX ADVENTURE ALU-BOX is designed exclusively for mounting on SW-MOTECH QUICK-LOCK side carriers, QUICK-LOCK adapter plate and STEEL-RACK adapter kit.

Modifications made to the cases will void any warranty.

ATTENTION: Riding with TRAX ADVENTURE ALU-BOX may affect the motorcycle's driving and braking performance.

ATTENTION: TRAX ADVENTURE ALU-BOXES M & L must be used in pairs. Make sure the weight is evenly distributed between left and right side case.

ATTENTION: Maximum load: Please refer to the mounting instructions of the SW-MOTECH QUICK-LOCK side carrier, ALU-RACK or STEEL-RACK. Maximum speed with mounted cases: 130 km/h (80 mph).

ATTENTION: Make sure that the TRAX ADVENTURE ALU-BOX is properly attached to the particular adapter and fully engaged to all four mounting points! ALL latches of the TRAX ADVENTURE ALU-BOX must be locked BEFORE riding with the TraX ® EVO / TRAX ADV lock cylinder set (sold separately) and remain closed while riding. Improperly mounted cases run the risk of detaching during transport.

CARE

To clean the TRAX ADVENTURE ALU-BOX, use warm, soapy water and a soft, clean cloth. Rinse with clean water. Do NOT use strong cleaning agents, rough cleaning tools or high pressure washer!



SW-MOTECH GmbH & Co. KG
Ernteweg 8/10
35282 Rauschenberg
Germany

Tel. / phone + 49 (0)6425 / 8168 - 050
Fax / fax + 49 (0)6425 / 8168 - 10
info@sw-motech.com
www.sw-motech.com

STÜCKLISTE / PARTS LIST

Seite / Page	Nr. No.	Art.-Nr. / Bezeichnung Item No. / Description	Artikel	Part	Anzahl * Quantity *	N-m
6+7	(1-3)		TRAX ADV ALU-BOX	TRAX ADV ALU-BOX	1 / 1	
5	(4)	ALK.00.733.041	Schnappverbindung	Snap-Fit	2 / 2	
	(5)	ALK.00.733.040 (L/R)	Deckelbegrenzer	Lid Limiter	2 / 2	
	(6)	ALK.00.733.042	Drehteil	Swivel Part	2 / 2	
	(7)	3 x 14; DIN 7500	Linsenkopfschraube, gewindefurchend	Lenhead Screw, self-tapping	4 / 4	0,5

Alle Maßangaben in Millimeter. / All measurements in millimeters. - * Der zweite Wert gibt die Gesamtanzahl des jeweiligen Artikels in der Lieferung an. / * The second number indicates the total quantity of the listed part in the delivery.

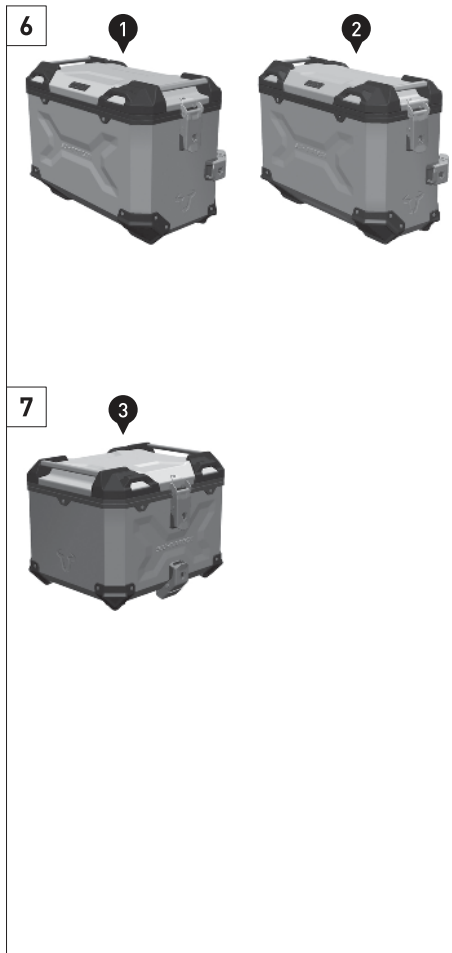

TECHNISCHE DETAILS / TECHNICAL DETAILS			
L 	Maße/Size 	Volumen Volume 45 l	Eigengewicht Empty weight 5,4 kg
M 	Maße/Size 	Volumen Volume 37 l	Eigengewicht Empty weight 5,1 kg
TC 	Maße/Size 	Volumen Volume 38 l	Eigengewicht Empty weight 4,6 kg
			Kapazität Capacity 1x

www.sw-motech.com

Bitte besuchen Sie unseren Webshop für Modelzuweisungen und passendem Zubehör. Please visit our webshop for application charts and compatible accessories.

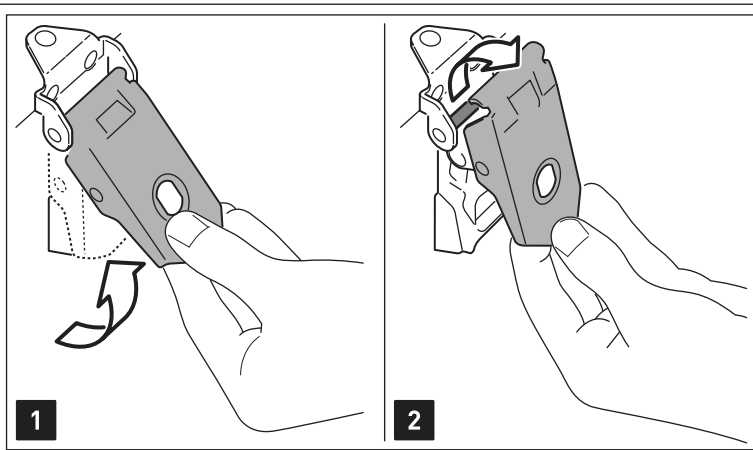
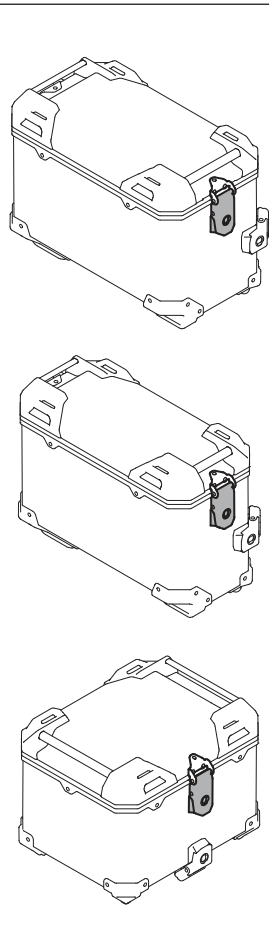

**Öffnen des Deckels
(TRAX ADV M / L / Topcase)**

- 1.- Ziehen Sie den Spannverschluss des Deckels nach oben ...
- 2.- ... und entfernen Sie diesen vom Spannverschlussbügel.
- 3.- Öffnen Sie anschließend den Deckel.

**Open the lid
(TRAX ADV M / L / topcase)**

- 1.- Pull the latch of the lid upwards ...
- 2.- ... and remove it from the latch bar.
- 3.- Open the lid.

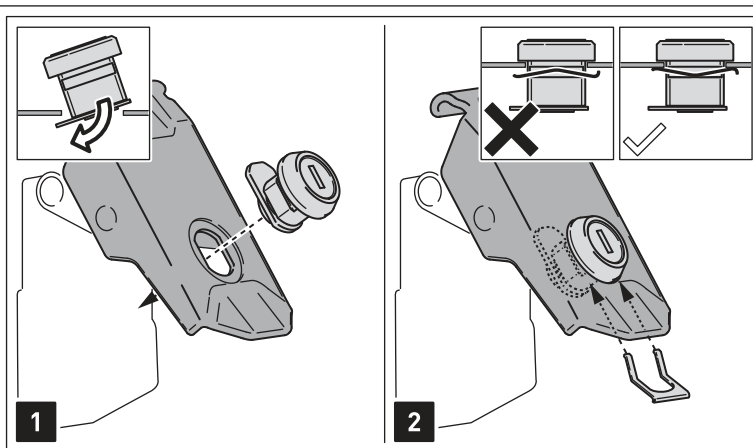
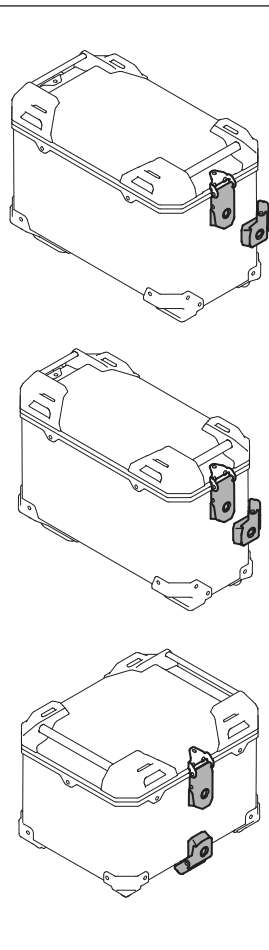
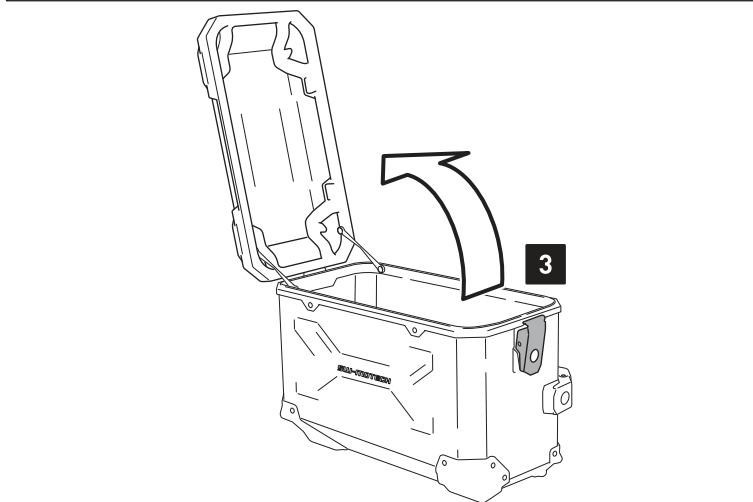

**Einsetzen des TraX® EVO / TRAX
ADV Schließzylinder-Satzes *
(TRAX ADV M / L / Topcase)**

- 1.- Setzen Sie die Schließzylinder in die Spannverschlüsse ein.
- 2.- Sichern Sie die Schließzylinder mit den Klemmblechen.
ACHTUNG: Achten Sie unbedingt auf die korrekte Ausrichtung der Klemmbleche (siehe Detailzeichnungen).
- 3.- Stecken Sie die Schlüssel in die Schließzylinder; öffnen bzw. schließen Sie die Schließzylinder, wie in der schematischen Zeichnung gezeigt.

ACHTUNG: Zum Schmieren NUR Grafitpulver verwenden!

* separat erhältlich.

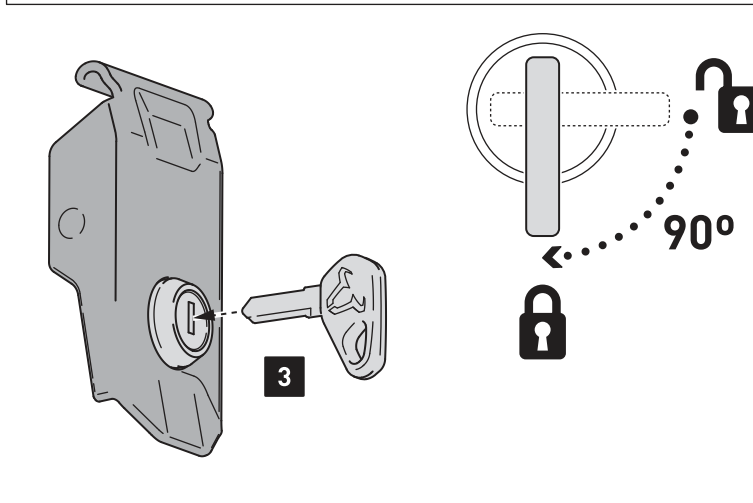

**Insertion of the TraX® EVO / TRAX
ADV lock cylinder set *
(TRAX ADV M / L / Topcase)**

- 1.- Insert the lock cylinders into the latches.
- 2.- Secure the lock cylinders with the clamping plates.
ATTENTION: Pay attention to the correct alignment of the clamping plates (as shown in the detail drawings).
- 3.- Insert the keys into the lock cylinders; open or close the lock cylinder as shown in the schematic drawing.

ATTENTION: Use for lubrication graphite powder ONLY!

* Sold separately.

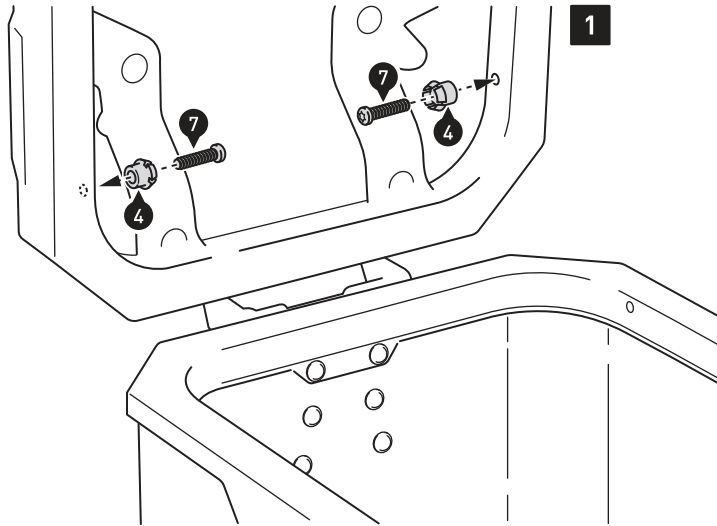
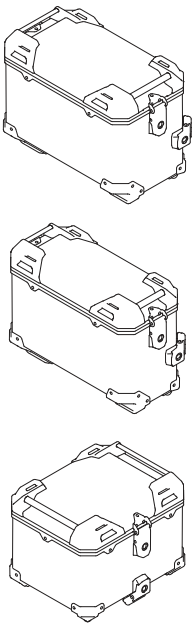

Montage der Deckelbegrenzer (TRAX ADV M / L / Topcase)

1.- Öffnen Sie den Deckel. Verschrauben Sie die Schnappverbindungen (4) mit den gezeigten Teilen am Deckelrahmen. Ziehen Sie die Schrauben wie in der Stückliste vorgegeben an.

2.- Verschrauben Sie die Deckelbegrenzer (5) mit den gezeigten Teilen am Korpusrahmen.

HINWEIS: Achten Sie auf die Links-Rechts-Spezifikation der Deckelbegrenzer (in Fahrtrichtung).

Ziehen Sie die Schrauben wie in der Stückliste vorgegeben an.

Drücken Sie die Deckelbegrenzer auf die Schnappverbindungen.

3.- Vor dem ersten Schließen müssen die Deckelbegrenzer ein wenig gestaucht werden, wie in der Zeichnung gezeigt.

Achten Sie beim Schließen des Deckels darauf, dass die Deckelbegrenzer nicht zwischen Deckel und Korpus geklemmt werden.

4.- Um den Deckel vom Korpus zu entfernen (siehe Seite 5), müssen zuvor die Deckelbegrenzer von den Schnappverbindungen gedrückt werden.

Mounting the lid limiters (TRAX ADV M / L / top case)

1.- Open the lid. Attach the snap-fit (4) with the shown parts at the lid frame. Tighten the screws as specified in the parts list.

2.- Attach the lid limiters (5) with the shown parts at the case frame.

NOTE: Pay attention to left-right specifications for the limiters (in driving direction).

Tighten the screws as specified in the parts list.

Press the lid limiters onto the snap-fits.

3.- Before closing the lid for the first time, the lid limiters must be compressed as shown in the drawing.

While closing the lid, make sure that the lid limiters are not pinched between lid and case.

4.- To remove the lid from the case (as shown on page 5), remove the lid limiters from the snap-fits first.

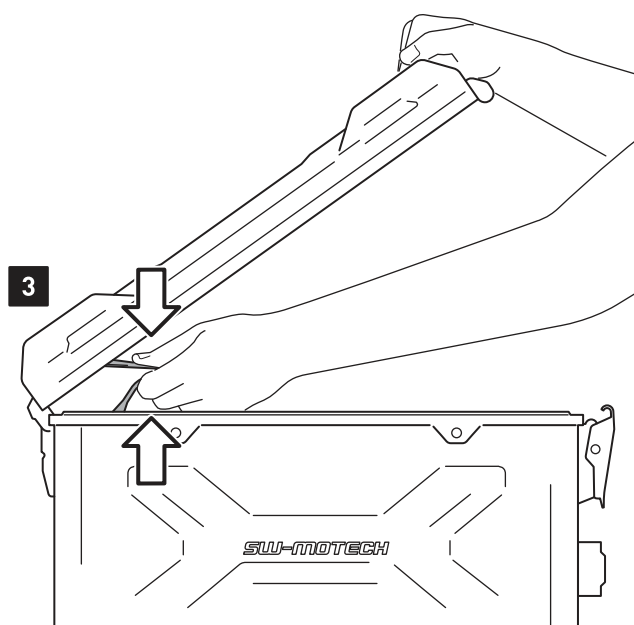
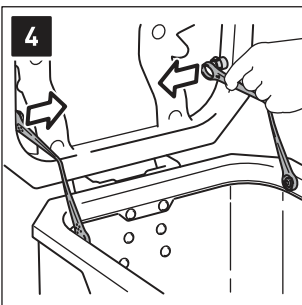
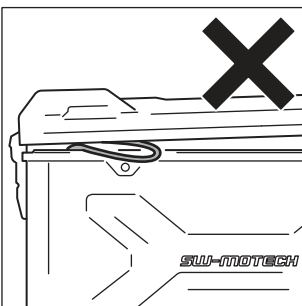
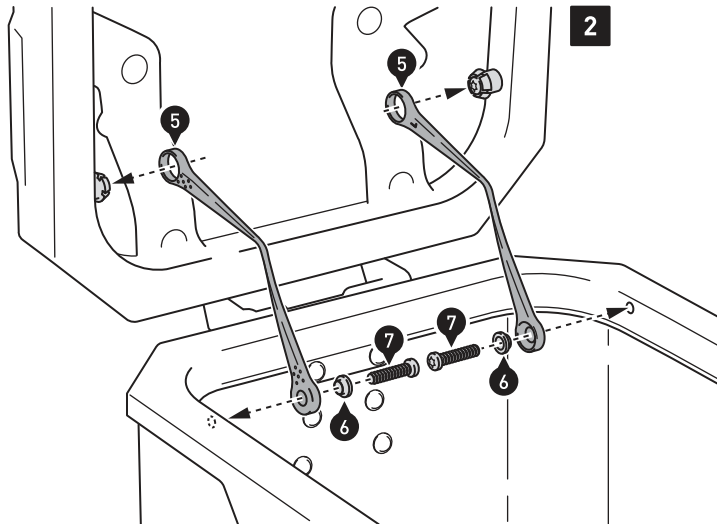
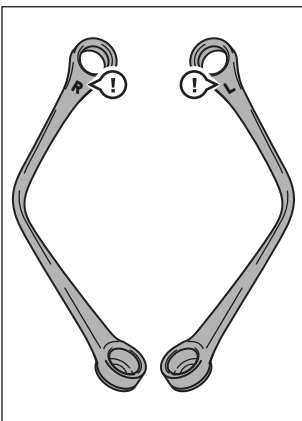

	<p>1</p> <p>2</p> <p>3</p>	<p>Entfernen des Deckels (TRAX ADVENTURE M / L)</p> <p>1.- Drücken Sie den Schnellverschluss nach unten, bis dieser einrastet und der Knopf heraus-springt.</p> <p>2.- Anschließend kann der Deckel vom Korpus entfernt werden.</p> <p><i>HINWEIS: Wenn Sie die Deckelbegrenzer (5) montiert haben, müssen diese vor Entfernen des Deckels gelöst werden (siehe Seite 4).</i></p> <p>3.- Um den wieder aufgesetzten Deckel zu verschließen, drücken Sie den Knopf des Schnellverschlusses. Achten Sie darauf, dass der Schnellverschluss oben einrastet.</p> <p>Removing the lid (TRAX ADVENTURE M / L)</p> <p>1.- Press the quick release fastener down until it clicks into place and the button pops out.</p> <p>2.- Then remove the lid from the case.</p> <p><i>NOTE: If you have installed the lid limiters (5), they must be detached before removing the lid (as shown on page 4).</i></p> <p>3.- Press the button of the quick release fastener to lock the replaced lid in place. Make sure that the quick release fastener snaps above.</p>
--	---	--

<p>1</p>	<p>3</p>	<p>Wartung und Reinigung des Schnellverschlusses (TRAX ADVENTURE M / L)</p> <p>1.- Lösen Sie die innenseitig verbauten Schrauben und entfernen Sie den Schnellverschluss vom Korpus.</p> <p>2.- Lösen Sie die Schraube des Knopfes (mit Daumen und Zeigefinger fixieren).</p> <p>3.- Lösen Sie vorsichtig den gezeigten Clip und ...</p> <p>4.- ... entfernen Sie Schnellverschluss und Federn vom Halteblech.</p> <p>5.- Reinigen Sie die Komponenten mit klarem Wasser und lassen Sie diese anschließend an der Luft trocknen. Verbauen Sie die Komponenten nun in umgekehrter Reihenfolge am Korpus.</p>
<p>2</p>	<p>4</p> <p>5</p>	<p>Maintenance and cleaning of the quick release fastener (TRAX ADVENTURE M / L)</p> <p>1.- Loosen the six screws on the inner side of the case and remove the quick release fastener.</p> <p>2.- Loosen the screw of the button (fix with thumb and index finger).</p> <p>3.- Loosen the shown clip carefully and ...</p> <p>4.- ... remove the quick release fastener and springs from the mounting plate.</p> <p>5.- Clean the components with clean water and let it air dry. Reattach all parts in reversed order.</p>

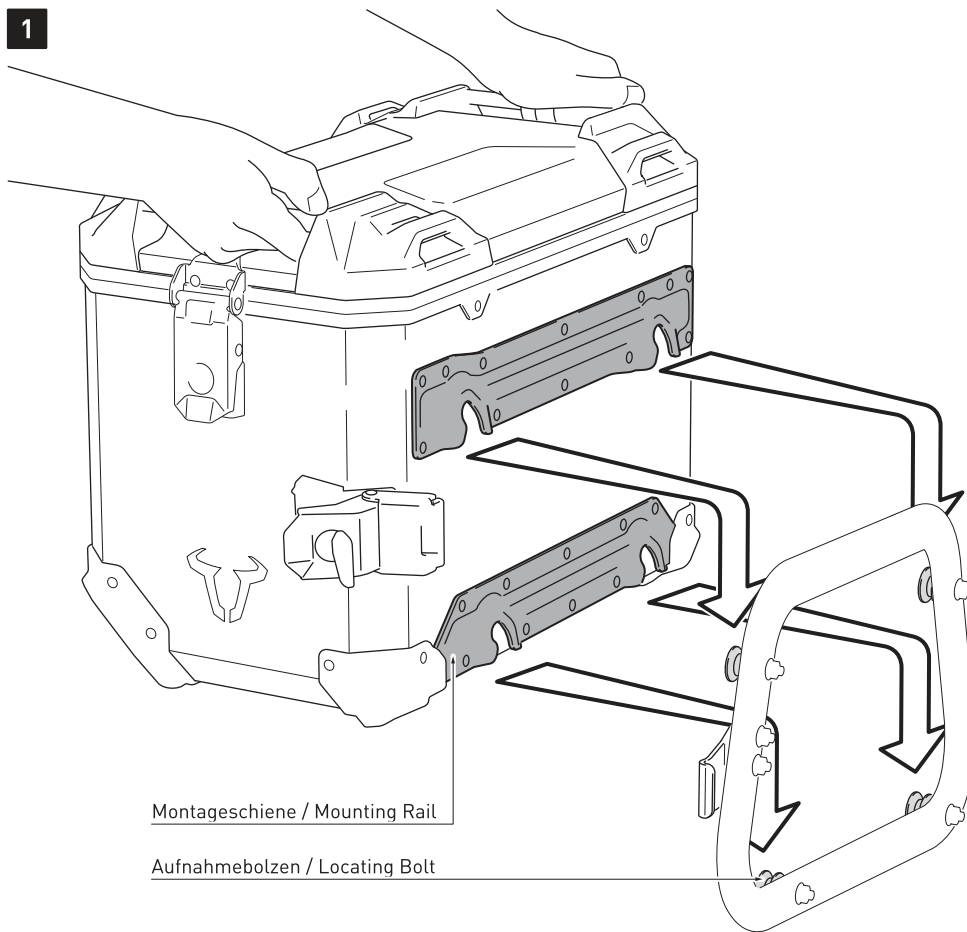

Befestigung der TRAX ADVENTURE ALU-BOX M & L

1.- Führen Sie die vier Öffnungen der Montageschienen über die Aufnahmebolzen des montierten QUICK-LOCK Adapterkits.

Drücken Sie anschließend die TRAX ADVENTURE ALU-BOX leicht nach unten, bis diese fest am QUICK-LOCK Kofferträger sitzt.

ACHTUNG: Achten Sie darauf, dass alle vier Aufnahmebolzen gleichzeitig einrasten.

2.- Legen Sie den seitlichen Spannverschluss über den Vorspannwinkel und ...

3.- ... klappen Sie den Spannverschluss um; überprüfen Sie den festen Sitz der TRAX ADVENTURE ALU-BOX am QUICK-LOCK Kofferträger.

ACHTUNG: Achten Sie darauf, dass der Spannverschluss unter ausreichend Spannung steht! Andernfalls muss der Vorspannwinkel nachjustiert werden!

ACHTUNG: Sichern Sie die TRAX ADVENTURE ALU-BOX vor Fahrtbeginn mit dem separat erhältlichen TraX® EVO / TRAX ADVENTURE Schließzylinder-Satz am QUICK-LOCK Kofferträger!

Attachement of TRAX ADVENTURE ALU-BOX M & L

1.- Lead the four openings of the mounting rails onto the locating bolts of the mounted QUICK-LOCK adapter kit.

Then press the TRAX ADVENTURE ALU-BOX slightly downward, until it properly rests on QUICK-LOCK side carrier.

ATTENTION: Make sure that all four locating bolts rests on at the same time.

2.- Place the latch over the latch hook and ...

3.- ... close the latch; check the proper fit of the TRAX ADVENTURE ALU-BOX on the QUICK-LOCK side carrier.

ATTENTION: Make sure the closed latch is under sufficient tension! If not the latch hook must be readjusted!

ATTENTION: Secure the TRAX ADVENTURE ALU-BOX with the separately available TraX® EVO / TRAX ADVENTURE lock cylinder set at the QUICK-LOCK side carrier before riding!

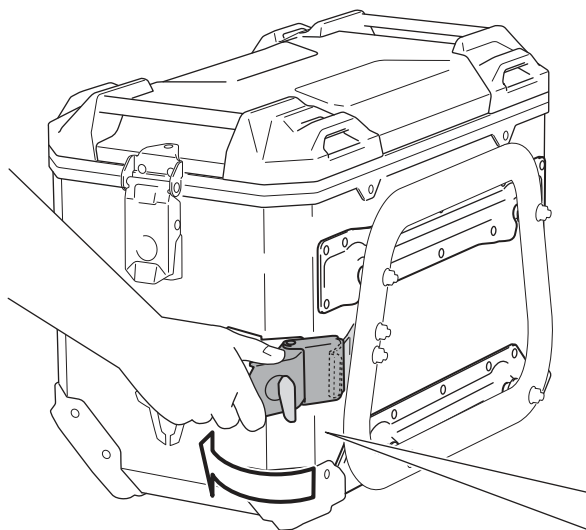

2

Vorspannwinkel / Latch Hook

Spannverschluss / Latch

3

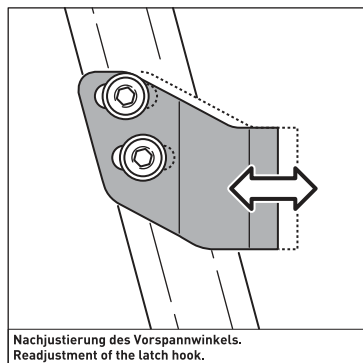

Nachjustierung des Vorspannwinkels.
Readjustment of the latch hook.

1

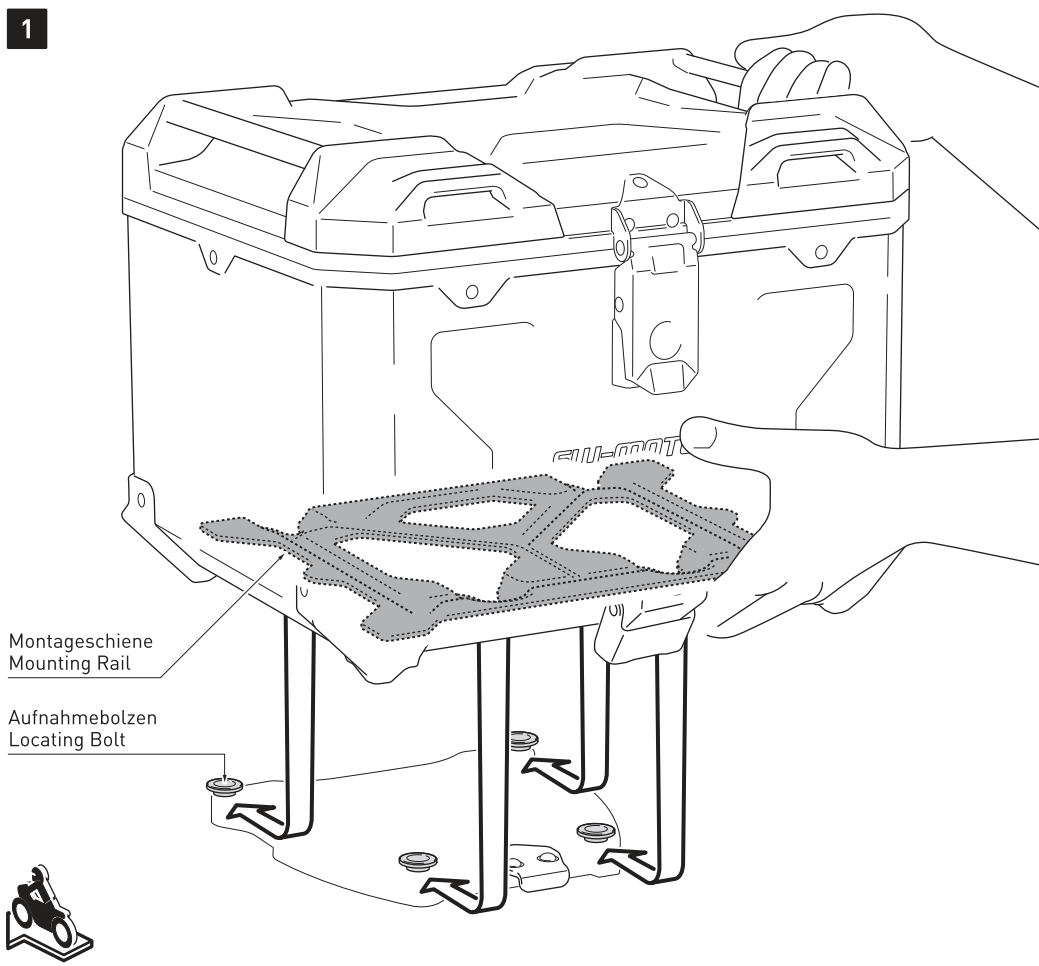

Befestigung der TRAX ADVENTURE ALU-BOX TC

1.- Führen Sie die vier Öffnungen der Montageschiene über die Aufnahmebolzen der montierten QUICK-LOCK Adapterplatte / STEEL-RACK Adapterkit.

Drücken Sie anschließend die TRAX ADVENTURE ALU-BOX leicht nach vorne, bis diese fest auf der QUICK-LOCK Adapterplatte / STEEL-RACK Adapterkit sitzt.

ACHTUNG: Achten Sie darauf, dass alle vier Aufnahmebolzen gleichzeitig einrasten.

2.- Führen Sie den unteren Spannverschluss über den Vorspannwinkel und ...

3.- ... klappen Sie den Spannverschluss um; überprüfen Sie den festen Sitz der TRAX ADVENTURE ALU-BOX auf der QUICK-LOCK Adapterplatte / STEEL-RACK Adapterkit.

ACHTUNG: Achten Sie darauf, dass der Spannverschluss unter ausreichend Spannung steht! Andernfalls muss der Vorspannwinkel nachjustiert werden!

ACHTUNG: Sichern Sie die TRAX ADVENTURE ALU-BOX vor Fahrtbeginn mit dem separat erhältlichen TraX® EVO / TRAX ADVENTURE Schließzylinder-Satz an der QUICK-LOCK Adapterplatte / STEEL-RACK Adapterkit!

Attachement of TRAX ADVENTURE ALU-BOX M & L

1.- Lead the four openings of the mounting rail onto the locating bolts of the mounted QUICK-LOCK adapter plate / STEEL-RACK adapter kit.

Then press the TRAX ADVENTURE ALU-BOX slightly forward, until it properly rests on QUICK-LOCK adapter plate / STEEL-RACK adapter kit.

ATTENTION: Make sure that all four locating bolts rests on at the same time.

2.- Place the latch over the latch hook and ...

3.- ... close the latch; check the proper fit of the TRAX ADVENTURE ALU-BOX on the QUICK-LOCK Adapter Plate / STEEL-RACK Adapter Kit.

ATTENTION: Make sure the closed latch is under sufficient tension! If not the latch hook must be readjusted!

ATTENTION: Secure the TRAX ADVENTURE ALU-BOX with the separately available TraX® EVO / TRAX ADVENTURE lock cylinder set at the QUICK-LOCK adapter plate / STEEL-RACK adapter kit before riding!

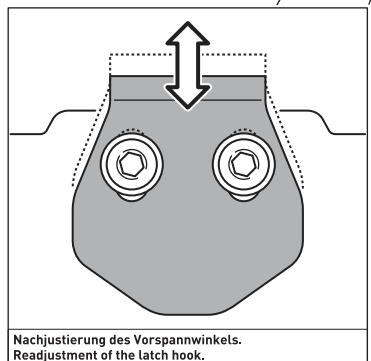
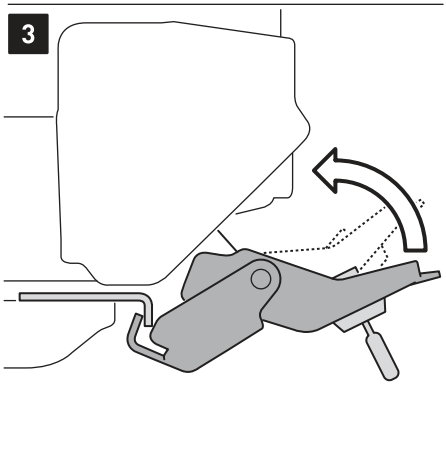
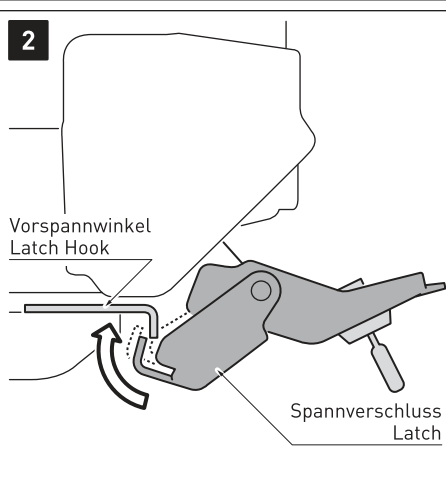
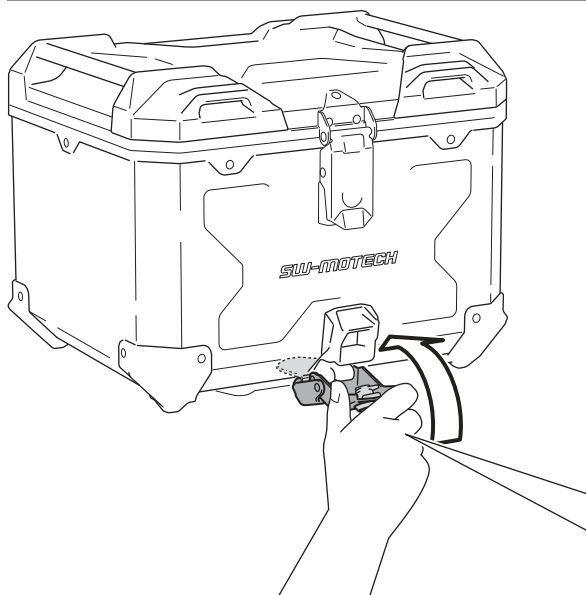

Nachjustierung des Vorspannwinkels. Readjustment of the latch hook.

TRAX ADV

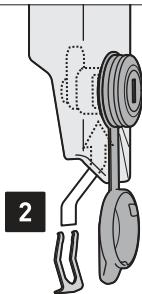
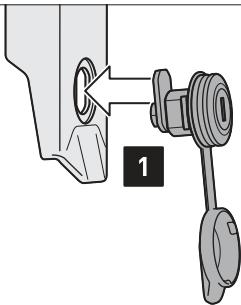

TRAX ION

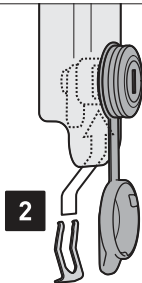
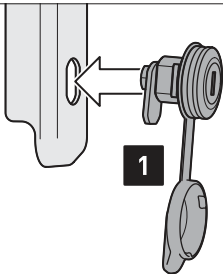

Revision: 00 - 05 - 2020

