

ANBAUANLEITUNG

mounting instructions • instructions de montage • instrucciones de montaje • istruzioni di montaggio

GPT.05.845.60000/B

beinhaltet • contains • contient • contiene • contiene

GPT.05.845.19000/B

GPT.00.152.35000/B

BC.HTA.00.677.20000/B

Numero di articolo: GPT.05.845.19000/B

Revisione: 00 · Data: 07 - 2023

Portabagagli ADVENTURE-RACK

 ~ 0.75 h.FACILE     DIFFICILE

ITALIANO -Grazie per aver scelto questo prodotto premium di SW-MOTECH. Visita il nostro negozio online per ulteriori informazioni (ad es. per la compatibilità con i vari modelli). I documenti richiesti (ad es. certificato di omologazione nazionale) possono essere scaricati qui.

Si prega di leggere attentamente le avvertenze di sicurezza e le istruzioni per il montaggio prima di montare e utilizzare il prodotto, al fine di evitare eventuali lesioni e danni. Conserva queste istruzioni per il montaggio come riferimento futuro.

Questo prodotto è stato sviluppato per veicoli in condizioni di fabbrica. La compatibilità con gli accessori originali o di altri produttori non può essere garantita.

Queste istruzioni per il montaggio sono state redatte in base alle nostre conoscenze attuali. Non sussistono pretese di correttezza giuridiche. Salvo errori ed omissioni. Ci riserviamo il diritto di apportare modifiche tecniche e di design. Copyright SW-MOTECH.

SIMBOLO DI SICUREZZA

 Questo simbolo di avvertenza è usato nelle presenti istruzioni di montaggio per segnalare pericoli mortali, rischio di lesioni o altri pericoli. Le parole "PERICOLO", "AVVERTENZA" O "ATTENZIONE" sono utilizzate con questo simbolo di avvertenza per trasmettere importanti istruzioni di sicurezza e informazioni relative al montaggio e all'uso di questo prodotto. Queste parole, utilizzate insieme al simbolo di avvertenza, significano:

▲ PERICOLO: indica una situazione di pericolo che, se non evitata, può causare morte o lesioni gravi!

▲ AVVERTENZA: indica una situazione di pericolo che, se non evitata, può causare morte o lesioni gravi!

▲ ATTENZIONE: indica una situazione di pericolo che, se non evitata, può provocare lesioni lievi o di entità moderata!

▲ AVVISO: indica informazioni importanti che non riguardano il rischio di morte o di lesioni (riguardano unicamente il rischio di danni materiali)!

INFORMAZIONI GENERALI

▲ AVVERTENZA: il montaggio e/o la manutenzione di questo prodotto richiedono competenze tecniche avanzate, strumenti adeguati e una buona conoscenza dell'uso della strumentazione e delle indicazioni relative alle coppie di serraggio. Per ragioni di sicurezza, SW-MOTECH raccomanda di far eseguire il montaggio e/o la manutenzione presso un'officina per motociclette qualificata e certificata.

▲ AVVERTENZA: se si decide di installare questo prodotto in autonomia, leggere attentamente le istruzioni per il montaggio prima del montaggio e dell'uso e seguire tutte le avvertenze per evitare lesioni gravi o mortali. Durante il montaggio e l'uso, seguire anche tutte le istruzioni pertinenti contenute nel manuale del veicolo. **SE NON SI COMPRENDONO TALI ISTRUZIONI, ANCHE SOLO IN PARTE, O SE SONO NECESSARI CHIARIMENTI, NON CERCARE DI MONTARE IL PRODOTTO IN AUTONOMIA SENZA CHIEDERE IL SUPPORTO DI SW-MOTECH!**

PREPARAZIONE: leggere attentamente le istruzioni per il montaggio e assicurarsi che siano disponibili tutti i componenti contenuti nella lista.

▲ ATTENZIONE: assicurarsi che il veicolo sia perfettamente fermo. Spegner il motore e togliere la chiave. Se necessario, lasciar raffreddare il motore/lo scarico. Scollegare la batteria quando si interviene sull'impianto elettrico. Usare esclusivamente strumenti idonei e indossare sempre occhiali e guanti protettivi durante le operazioni di montaggio e manutenzione. Chiedere aiuto a una seconda persona durante le fasi di montaggio e manutenzione.

MONTAGGIO: tutti i componenti e i collegamenti rimossi dal veicolo devono essere reinstallati secondo le specifiche del produttore del veicolo o sostituiti con componenti e attrezzatura forniti da SW-MOTECH.

▲ AVVERTENZA: fissare tutte le filettature con frenafili liquido a media resistenza, se non diversamente specificato.

▲ PERICOLO: le coppie di serraggio non definite da SW-MOTECH devono essere richieste al costruttore del veicolo o a un'officina certificata.

CONTROLLO DI FUNZIONALITÀ: dopo il montaggio accertarsi che non vi siano parti mobili bloccate e che il funzionamento del veicolo non sia compromesso. I cavi e i tubi flessibili non devono sfregare e/o essere schiacciati.

▲ AVVERTENZA: eseguire un controllo completo delle funzioni prima di mettersi alla guida. Controllare la coppia di serraggio di tutti i collegamenti e la tenuta del prodotto dopo i primi 50 km e in seguito regolarmente. Gli accessori montati possono modificare la maneggevolezza e la stabilità del veicolo.



SW-MOTECH GmbH & Co. KG
Ernteweg 7-10
35282 Rauschenberg
Germania



info@sw-motech.com
www.sw-motech.com



Consultare i simboli e il loro significato nella sezione MONTAGGIO. Se nella sezione montaggio compare la sigla OEM, è necessario rispettare e applicare le specifiche del produttore del veicolo.



Per qualsiasi domanda, non esitare a contattare il nostro servizio clienti o i nostri distributori. Il nostro numero di telefono e l'elenco dei nostri distributori sono disponibili nel nostro negozio online:

www.sw-motech.com



Usare un frenafiletto: indica che la filettatura deve essere rivestita con un frenafiletto liquido. H (ALTA): alta resistenza; M (MEDIA): media resistenza; L (BASSO): bassa resistenza.

























Serraggio / rispetto delle specifiche sulla coppia di serraggio: indica la coppia di serraggio di un componente specificata da SW-MOTECH o dal produttore del veicolo (OEM).



Non utilizzare il frenafiletto: segnala di non dover utilizzare il frenafiletto liquido in quel determinato punto.

ELENCO DELLE PARTI - LEGGI E CONSERVA LE ISTRUZIONI DI MONTAGGIO!

<p>2</p> <p>1</p>  <p>GPT.05.845.901.01.11</p> <p> 1/1</p>	<p>2</p>  <p>GPT.05.845.902.01.11</p> <p> 1/1</p>	<p>3</p>  <p>M6 x 16; ISO 7380 SC.ST.06.016.01.7380.109</p> <p> 2/2</p>	<p>4</p>  <p>M8 x 20; DIN 912 SC.ST.08.020.01.912.088</p> <p> 2/2</p>	<p>5</p>  <p>ø 8,4; DIN 9021 US.ST.084.01.9021.300</p> <p> 2/2</p>	<p>6</p>  <p>KES.RD.210.0300.02.GL</p> <p> 2/2</p>
<p>3</p> <p>7</p>  <p>M8 x 40; ISO 7380 SC.ST.08.040.02.7380.109</p> <p> 2/2</p>	<p>8</p>  <p>ø 8,4; DIN 9021 US.ST.084.02.9021</p> <p> 2/2</p>	<p>9</p>  <p>Ø 25 / Ø 8,4 / h 5 DB.ST.0250.0084.0050.02</p> <p> 2/4</p>	<p>10</p>  <p>Ø 30 / ø 10,5 / h 5 DB.ST.0300.0105.0050.02</p> <p> 2/2</p>		
<p>4</p> <p>11</p>  <p>GPT.05.845.001.11</p> <p> 1/1</p>	<p>12</p>  <p>M8 x 55; DIN 7991 SC.ST.08.055.02.7991.088</p> <p> 2/2</p>	<p>13</p>  <p>Ø 25 / ø 8,4 / h 25 DB.ST.0250.0084.0250.02</p> <p> 2/2</p>	<p>14</p>  <p>M8 x 70; DIN 7991 SC.ST.08.070.02.7991.088</p> <p> 2/2</p>	<p>15</p>  <p>Ø 25 / Ø 8,4 / h 5 DB.ST.0250.0084.0050.02</p> <p> 2/4</p>	<p>16</p>  <p>Ø 12 / ø 8,4 / h 28 DB.00.120.084.028.01</p> <p> 2/2</p>
<p>17</p>  <p>M8; DIN 6927 MU.ST.08.02.6927.08</p> <p> 2/2</p>					
<p>5</p> <p>18</p>  <p>GPT.00.152.002.11</p> <p> 1/1</p>	<p>19</p>  <p>M6 x 18; ISO 7380 SC.ST.06.018.02.7380.109</p> <p> 4/4</p>	<p>20</p>  <p>ø 6,4; DIN 9021 US.ST.064.02.9021</p> <p> 4/4</p>			

1

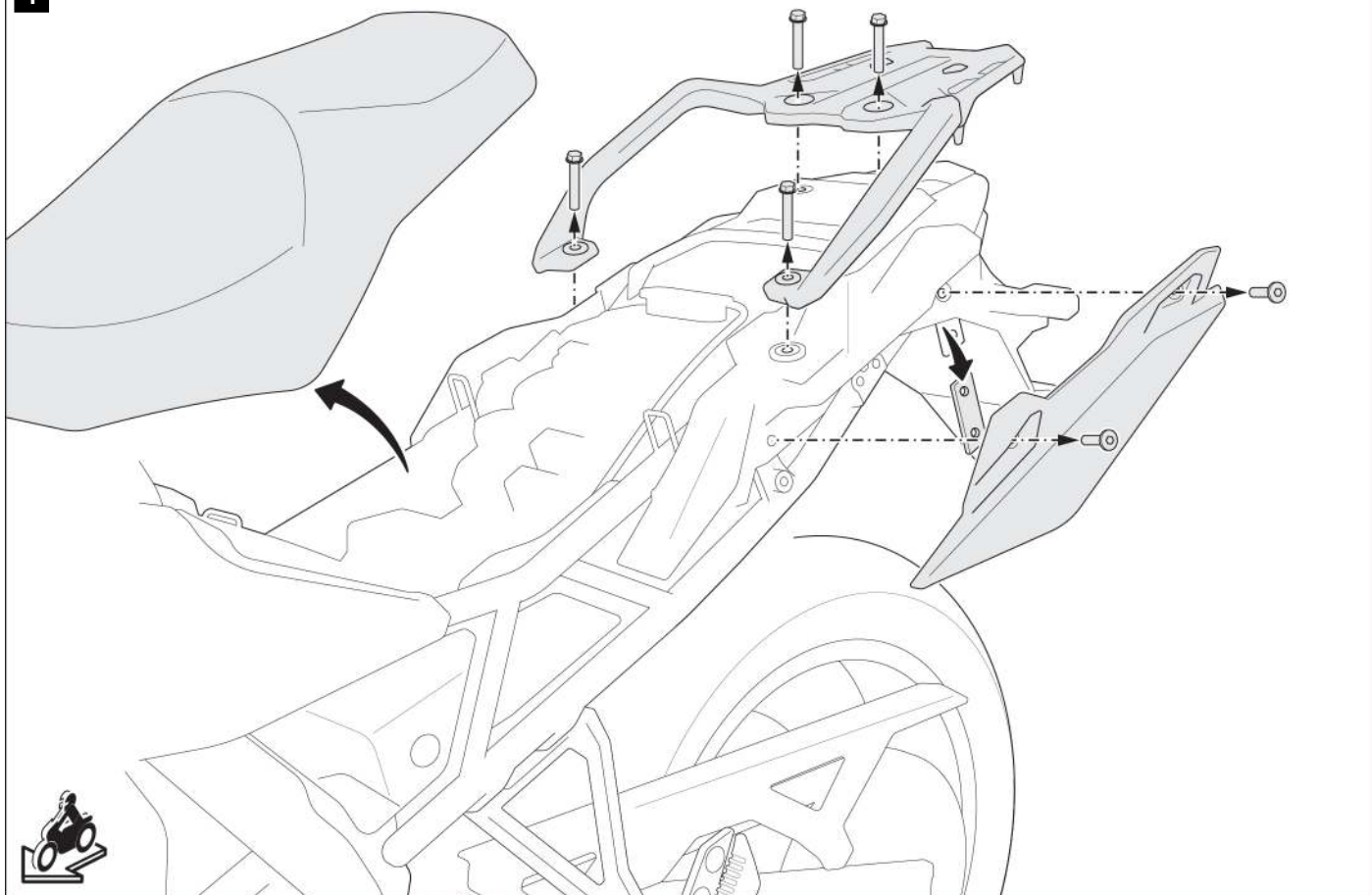

- ▲ **AVVERTENZA: indossare sempre le protezioni per gli occhi e le mani!**
- ▲ **AVVERTENZA: utilizzare sempre strumenti adeguati!**

Rimuovere la sella dal veicolo seguendo le istruzioni del manuale del produttore.

Allentare le viti indicate e rimuovere su entrambi i lati le parti della carenatura indicate nonché il portabagagli e il distanziale.

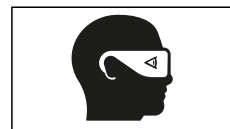

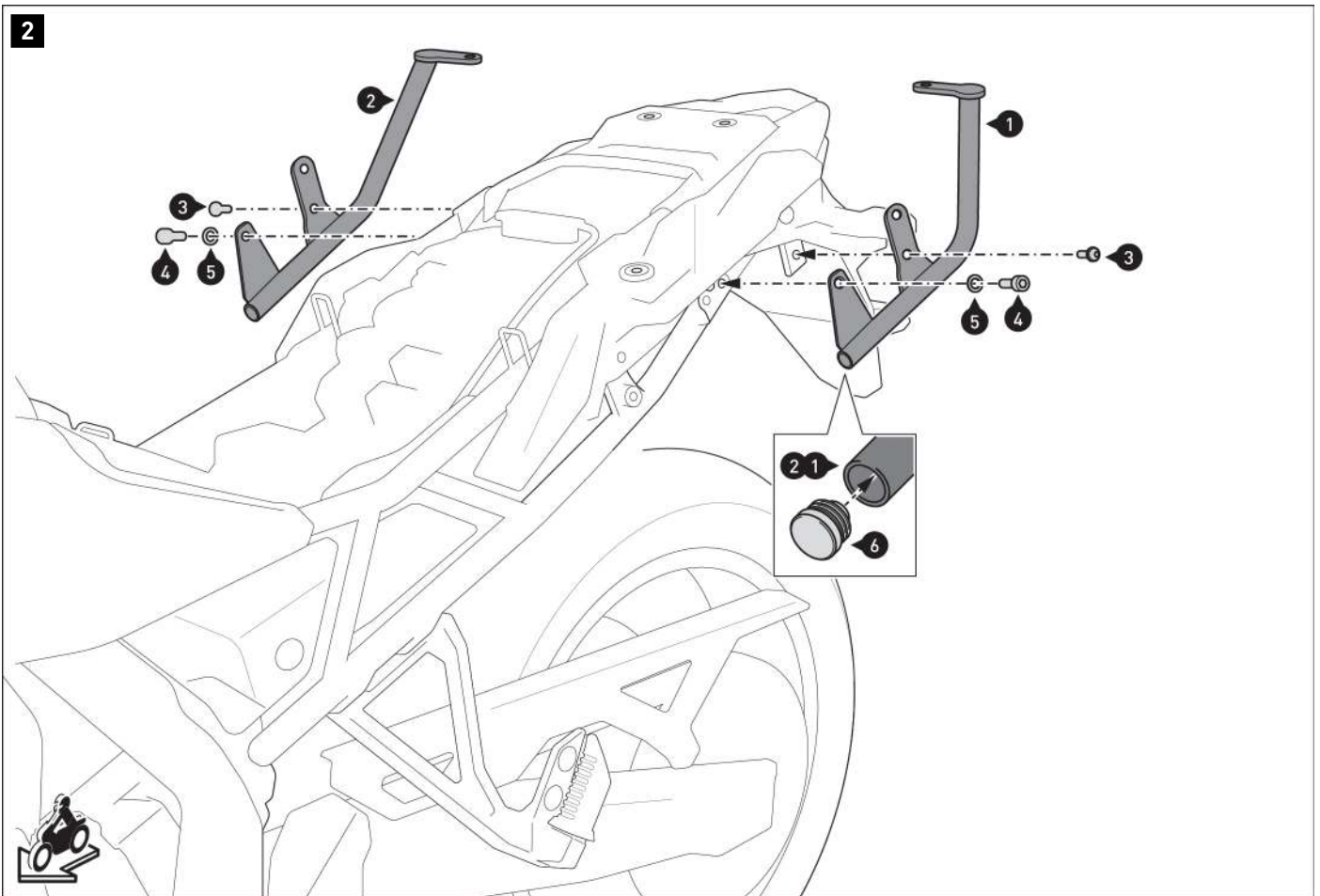

Inserire i tappi di plastica (6) nelle aperture dei telai laterali su entrambi i lati.

Avvitare i telai laterali (1) e (2) al veicolo.

⚠ AVVERTENZA: Usare un frenafiletti liquido!

Serrare le viti come indicato nelle istruzioni per il montaggio.

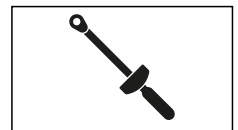
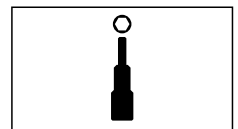
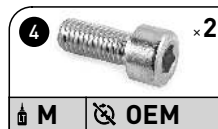
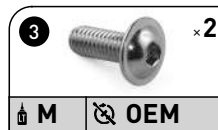

3

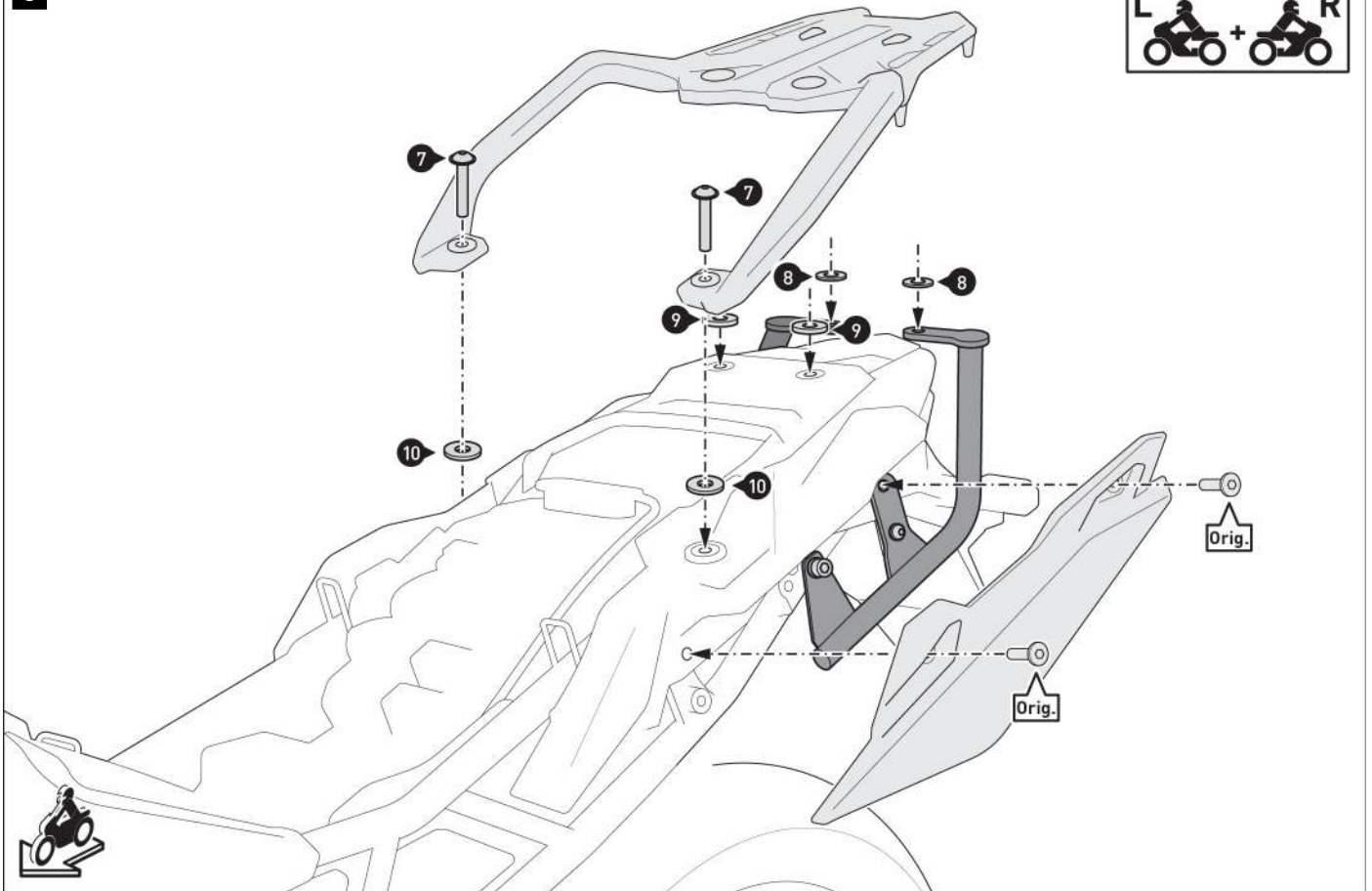

⚠ AVVISO: al momento del collegamento con il telaio laterale SW-MOTECH, i distanziali (9) e (10) non sono necessari. Al loro posto, montare il telaio laterale insieme alle parti del portabagagli.

Riavvitare il portabagagli originale e i pannelli laterali al veicolo.

⚠ AVVERTENZA: Usare un frenafiletto liquido!

Serrare le viti (7) e le viti originali (orig.) come specificato nelle istruzioni del produttore.

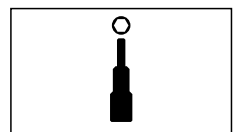
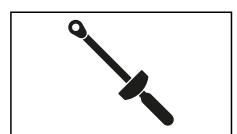

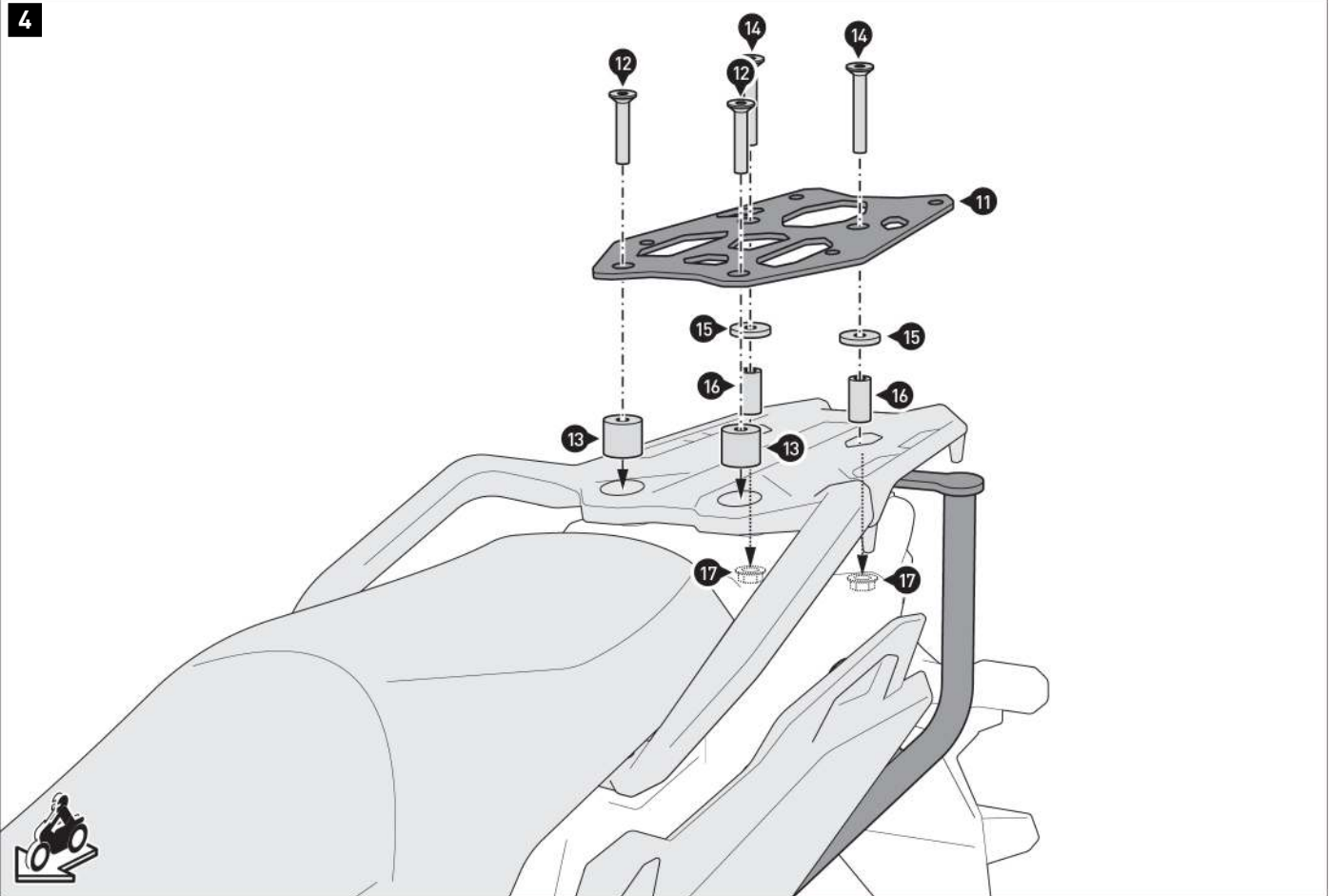

Avvitare la piastra adattatrice [11] al portabagagli originale.
▲ AVVERTENZA: per le viti (12), utilizzare un frenafiletto liquido!
 Serrare le viti (12) come specificato nelle istruzioni del produttore.
 Serrare le viti (14) come specificato nelle istruzioni per il montaggio.

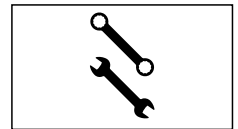
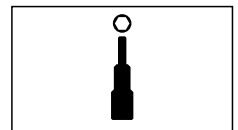
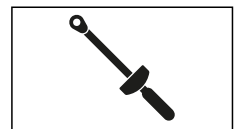
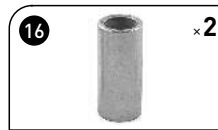

5

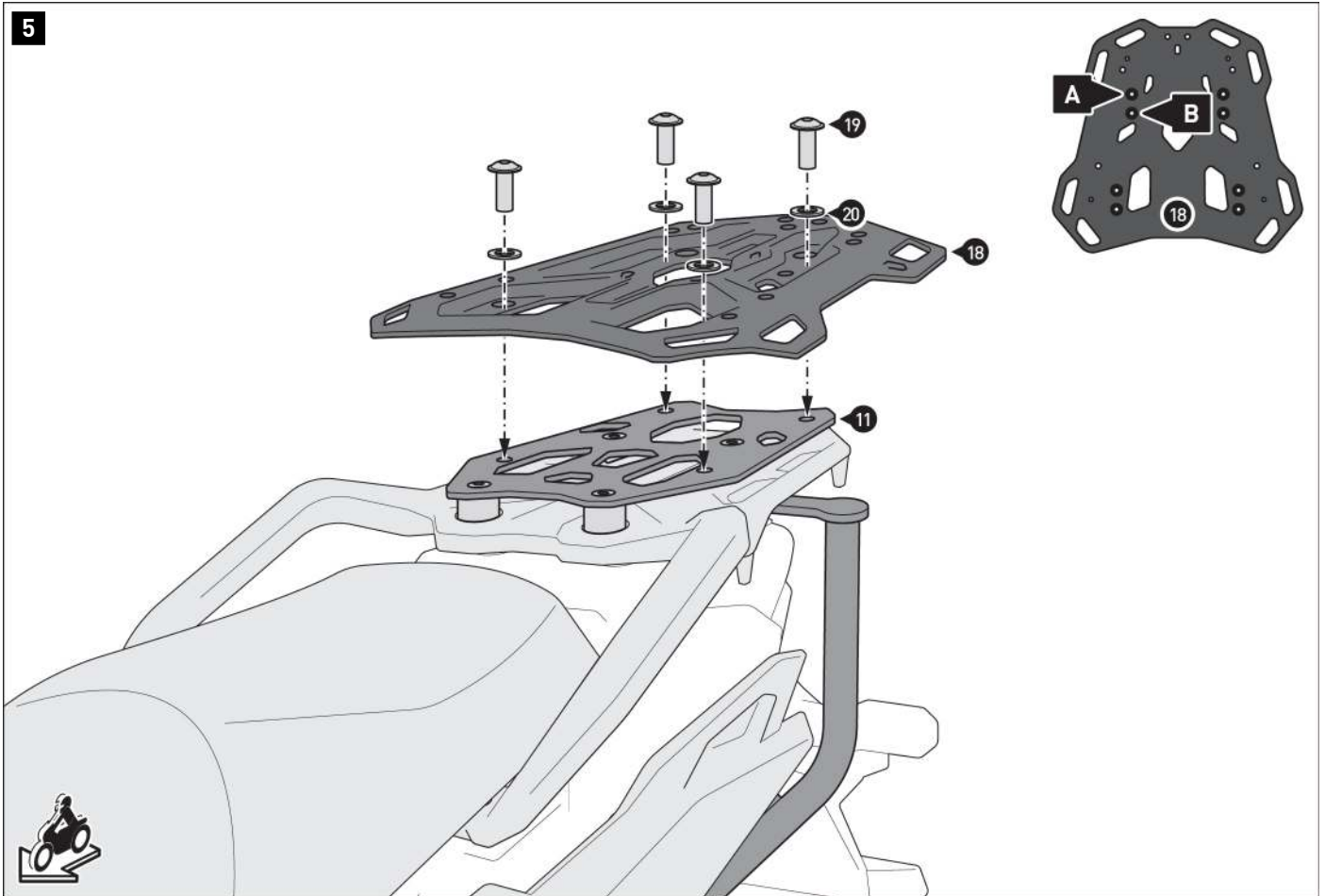

⚠ AVVISIO: evitare il portabagagli nella posizione di montaggio contrassegnata con (A) o (B), a seconda dello spazio disponibile, come indicato nel disegno dettagliato.

Montare il portabagagli (18) sulla piastra adattatrice (11).

⚠ AVVERTENZA: Usare un frenafilietti liquido!

Serrare le viti come indicato nelle istruzioni per il montaggio.



M 10 Nm

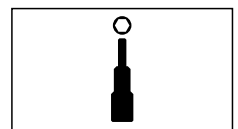
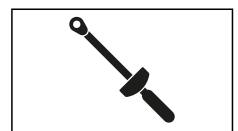

AVVERTENZE SPECIFICHE DEL PRODOTTO

⚠ AVVERTENZA: il carico massimo specificato comprende il peso della valigia/bagaglio e della piastra di adattamento/kit adattatore! Si applica il carico massimo del veicolo specificato dal costruttore del veicolo!



≤ 10 kg (≤ 22 lbs)



≤ 130 km/h (≤ 80 mph)

⚠ AVVISO: rispettare le normative specifiche del paese per l'immatricolazione/l'uso del veicolo, come le normative TÜV applicabili. Dopo il montaggio, far inserire le parti soggette a omologazione nei documenti del veicolo dal proprio centro di test.

Art.-Nr. / Item No.: GPT.00.152.35000/B

Revision: 01 · Datum / Date: 10 - 2018

Adapterkit für ADVENTURE-RACK Gepäckträger – Adapterplatte für STREET-RACK Gepäckträger

Adapter kit for ADVENTURE-RACK – Adapter plate for STREET-RACK

DEUTSCH - Vielen Dank, dass Sie sich für dieses Premium-Produkt von SW-MOTECH entschieden haben. Bitte besuchen Sie unseren Webshop für weitere Informationen wie Modellzuweisungen und PDF-Anbauanleitung. Erforderliche Dokumente (z. B. ABE) stehen als Download zur Verfügung.

Die Montage und/oder Wartung dieses Produkts erfordert ein gutes technisches Verständnis! Zu Ihrer eigenen Sicherheit empfiehlt SW-MOTECH, die Montage und/oder Wartung durch eine Fachwerkstatt durchführen zu lassen! SW-MOTECH übernimmt keine Haftung für Schäden, die durch eine unsachgemäße Montage und/oder Wartung verursacht wurden!

Beachten Sie alle in der Anbauanleitung angegebenen Hinweise und die für die Montage relevanten Informationen im Fahrzeughandbuch. Nichtbeachtung kann zu Schäden am Fahrzeug bzw. zur Gefährdung des Fahrers führen! Diese Anbauanleitung ist nach unserem derzeitigen Kenntnisstand verfasst worden. Rechtliche Ansprüche auf Richtigkeit bestehen nicht.

Dieses Produkt wurde für Fahrzeuge im Werkzustand entwickelt. Die Kompatibilität mit Original-Zubehörteilen bzw. den Zubehörteilen anderer Hersteller kann nicht gewährleistet werden. Stellen Sie des Weiteren VOR Montage dieses Produkts sicher, dass sich alle beweglichen Teile (z. B. die Kette) im ursprünglichen Wartungszustand befinden. Montiertes Zubehör kann das Fahrverhalten und/oder die Stabilität Ihres Fahrzeugs verändern.

ALLGEMEINE HINWEISE

Beachten Sie die landesspezifischen Vorschriften für Zulassung/Betrieb Ihres Fahrzeugs bzw. anwendbare TÜV-Vorschriften. Lassen Sie eintragungspflichtige Teile nach Montage durch Ihre Prüfstelle in die Fahrzeugpapiere eintragen.

VORBEREITUNG: Lesen Sie die Anbauanleitung aufmerksam und stellen Sie sicher, dass alle Teile der Stückliste vorhanden sind. Achten Sie darauf, dass Ihr Fahrzeug sicher steht und nicht umfallen kann. Schalten Sie den Motor ab und ziehen Sie den Zündschlüssel. Lassen Sie ggf. den Motor/Auspuff abkühlen. Klemmen Sie bei Arbeiten an der Elektrik die Fahrzeugbatterie ab. Verwenden Sie geeignetes Werkzeug. Lassen Sie sich von einer zweiten Person helfen.

MONTAGE: Alle vom Motorrad gelösten Teile und Verbindungen sind gemäß den Fahrzeugherstellereangaben wieder zu montieren oder durch die von SW-MOTECH gelieferten Teile zu ersetzen. Sichern Sie, falls nicht anderweitig definiert, alle Gewinde mit mittelfester, flüssiger Schraubensicherung.

Alle nicht durch SW-MOTECH definierten Anzugsmoment-Vorgaben müssen beim Fahrzeughersteller oder einer Fachwerkstatt erfragt werden!

FUNKTIONSKONTROLLE: Stellen Sie nach der Montage sicher, dass alle zuvor gelösten Teile und Verbindungen wieder ordnungsgemäß montiert wurden. Achten Sie außerdem auf die uneingeschränkte Freigängigkeit und einwandfreie Funktion sämtlicher Fahrzeugteile. Kabel, Züge und Schläuche dürfen nicht scheuern und/oder geklemmt werden. Führen Sie vor Fahrtbeginn eine umfassende Funktionskontrolle durch. Überprüfen Sie nach den ersten 50 km und anschließend in regelmäßigen Abständen das Anzugsmoment aller Schraubverbindungen und den ordnungsgemäßen Sitz des Produkts.

ENGLISH - Thank you for choosing this premium product from SW-MOTECH. Please visit our webshop for additional information, such as application charts and PDF mounting instructions. Any other documents that may be required (e.g. ABE certifications), are also available for download at our webshop.

Installation and/or maintenance of this product require good technical understanding! For your own safety SW-MOTECH recommends having installation and/or servicing carried out by a specialist workshop! SW-MOTECH assumes no liability for damage caused by improper installation and/or maintenance work!

Carefully follow all the directions given in the mounting instructions and pay attention to all relevant information in the vehicle manual during assembly. Nonconformance can lead to vehicle damage or even endanger the driver! These mounting instructions are written based on our current state of knowledge. Legal requirements for accuracy do not exist.

This product was developed for vehicles in their factory setting. Compatibility with original accessory parts or other manufacturers' accessory parts is not guaranteed. Furthermore, BEFORE installing this product, make sure that all moving parts (e.g. the chain) are in the original state of maintenance. Installed accessories can change the driving behaviour and/or stability of your vehicle.

GENERAL INFORMATION

Observe the country-specific regulations concerning vehicle registration/operation as well as TÜV regulations if applicable. If required, register installed parts in the vehicle documents through an appropriate inspection authority.

PREPARATION: Read the mounting instructions carefully and make sure that all items of the parts list are included. Make sure that your vehicle is parked safely and cannot fall over. Turn off the engine and remove the ignition key. Let the motor/exhaust cool off if necessary. Disconnect the vehicle battery when working on the electrical system. Use appropriate tools. Have another person to help you.

MOUNTING: All parts and connections removed from the vehicle must be reinstalled in accordance with the vehicle manufacturers' specifications or replaced by parts delivered by SW-MOTECH. Secure all threads, unless otherwise specified, with medium-strength liquid thread locker.

Torque specifications undefined by SW-MOTECH must be obtained from the vehicle manufacturer or by a specialist workshop!

FUNCTION CHECK: After installation make sure that all parts and connections previously removed are properly replaced. Also make sure that no moving parts are obstructed and no function of the vehicle is hindered in any way. Cables and hoses must not rub and/or be pinched. Before starting to ride, perform a comprehensive check of all functions. After the first 50 km and then at regular intervals, check the tightening torque of all screw connections and the proper fit of the product.

Konfektionierung durch / Packed by:

Datum der Konfektionierung / Date of packaging:



SW-MOTECH GmbH & Co. KG

Ernteweg 8/10
35282 Rauschenberg
Germany

Tel. / phone + 49 (0)6425 / 8168 - 050
Fax / fax + 49 (0)6425 / 8168 - 10

info@sw-motech.com
www.sw-motech.com

ADVENTURE-RACK Gepäckträger
ADVENTURE RACK

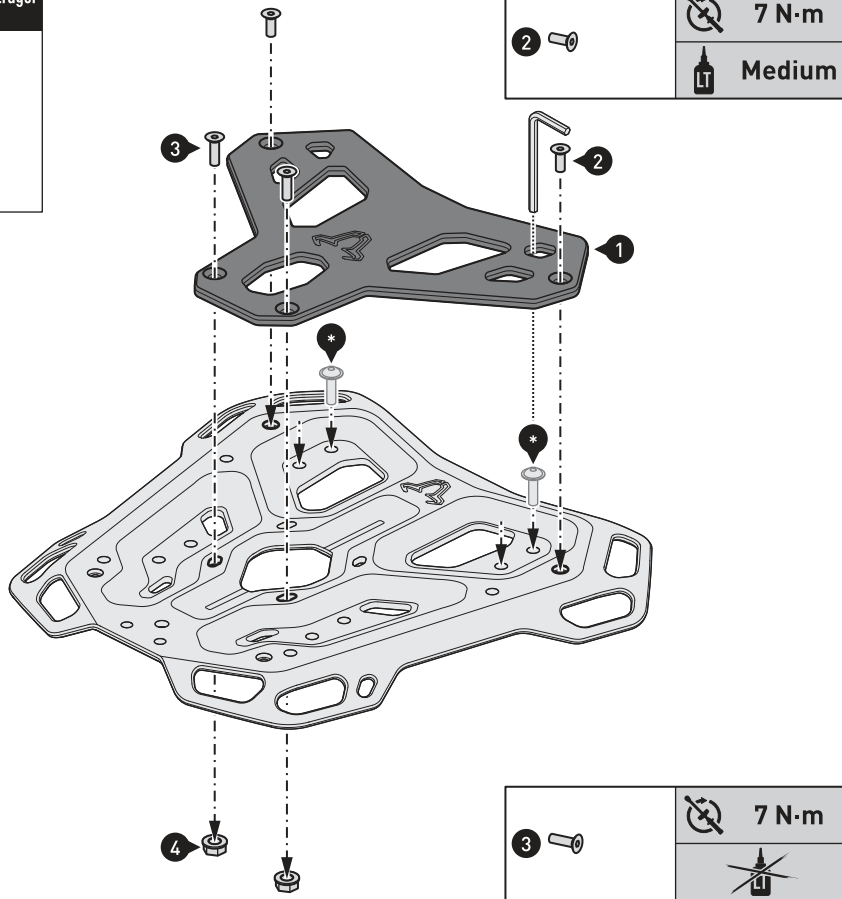
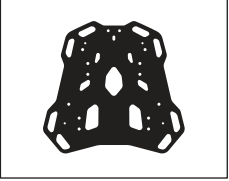

ADVENTURE-RACK Gepäckträger

HINWEIS: Setzen Sie VOR Montage des Anbaublechs (1) die dem ADVENTURE-RACK beiliegenden Schrauben (*) in die hinteren Öffnungen ein. Die Schrauben (*) können nach Montage des Anbaublechs durch die Aussparungen angezogen werden.

Verschrauben Sie das Anbaublech (1) an ihrem ADVENTURE-RACK Gepäckträger (separat erhältlich), wie in der Zeichnung gezeigt.

ACHTUNG: Verwenden Sie flüssige Schraubensicherung (nur Schrauben (2))!

Ziehen Sie die Schrauben wie in der Stückliste vorgegeben an.

ADVENTURE RACK

NOTE: BEFORE attaching the mounting bracket (1), insert the screws (*) supplied with the ADVENTURE-RACK into the rear openings. The screws (*) can be tightened after attaching the mounting plate through the cutouts.

Attach the mounting bracket (1) to your ADVENTURE RACK (sold separately), as shown in the drawing.

ATTENTION: Use liquid thread locker (screws (2) only)!

Tighten the screws as specified in the parts list.



Art.-Nr. / Item No.: **BC.HTA.00.677.21000/B & BC.HTA.00.677.22000/B**

Revision: **00** · Datum / Date: **12 - 2018**

URBAN ABS Topcase

URBAN ABS top case

DEUTSCH - Vielen Dank, dass Sie sich für dieses Premium-Produkt von SW-MOTECH entschieden haben. Bitte besuchen Sie unseren Webshop für weitere Informationen wie Modellzuweisungen und PDF-Anbauanleitung. Erforderliche Dokumente (z. B. ABE) stehen als Download zur Verfügung.

Die Montage und/oder Wartung dieses Produkts erfordert ein gutes technisches Verständnis! Zu Ihrer eigenen Sicherheit empfiehlt SW-MOTECH, die Montage und/oder Wartung durch eine Fachwerkstatt durchführen zu lassen! SW-MOTECH übernimmt keine Haftung für Schäden, die durch eine unsachgemäße Montage und/oder Wartung verursacht wurden!

Beachten Sie alle in der Anbauanleitung angegebenen Hinweise und die für die Montage relevanten Informationen im Fahrzeughandbuch. Nichtbeachtung kann zu Schäden am Fahrzeug bzw. zur Gefährdung des Fahrers führen! Diese Anbauanleitung ist nach unserem derzeitigen Kenntnisstand verfasst worden. Rechtliche Ansprüche auf Richtigkeit bestehen nicht.

Dieses Produkt wurde für Fahrzeuge im Werkzustand entwickelt. Die Kompatibilität mit Original-Zubehörteilen bzw. den Zubehörteilen anderer Hersteller kann nicht gewährleistet werden. Stellen Sie des Weiteren VOR Montage dieses Produkts sicher, dass sich alle beweglichen Teile (z. B. die Kette) im ursprünglichen Wartungszustand befinden. Montiertes Zubehör kann das Fahrverhalten und/oder die Stabilität Ihres Fahrzeugs verändern.

ALLGEMEINE HINWEISE

Beachten Sie die landesspezifischen Vorschriften für Zulassung / Betrieb Ihres Fahrzeugs bzw. anwendbare TÜV-Vorschriften. Lassen Sie eintragungspflichtige Teile nach Montage durch Ihre Prüfstelle in die Fahrzeugpapiere eintragen.

VORBEREITUNG: Lesen Sie die Anbauanleitung aufmerksam und stellen Sie sicher, dass alle Teile der Stückliste vorhanden sind. Achten Sie darauf, dass Ihr Fahrzeug sicher steht und nicht umfallen kann. Schalten Sie den Motor ab und ziehen Sie den Zündschlüssel. Lassen Sie ggf. den Motor / Auspuff abkühlen. Klemmen Sie bei Arbeiten an der Elektrik die Fahrzeugbatterie ab. Verwenden Sie geeignetes Werkzeug. Lassen Sie sich von einer zweiten Person helfen.

FUNKTIONSKONTROLLE: Da es sich um ein universelles Produkt handelt, stellen Sie unbedingt VOR der ersten Nutzung sicher, dass sich das Produkt ohne Probleme und sachgerecht an Ihrem Fahrzeugtyp befestigen und verwenden lässt. Achten Sie nach der Befestigung auf die uneingeschränkte Freigängigkeit und einwandfreie Funktion sämtlicher Fahrzeugteile. Leuchtmittel wie Rücklicht und Blinker dürfen nicht in ihrer Funktion eingeschränkt werden. Kabel, Züge und Schläuche dürfen nicht scheuern und/oder geklemmt werden. Führen Sie vor Fahrtbeginn eine umfassende Funktionskontrolle durch.

PRODUKTSPEZIFISCHE HINWEISE

ACHTUNG: Das Fahr-/Bremsverhalten des Motorrads verändert sich nach Befestigung dieses Produkts merklich!

ACHTUNG: Überprüfen Sie vor Fahrtbeginn und bei jeder Rast (alle 200 km) den ordnungsgemäßen Sitz des Produkts!

Maximale Zuladung	Höchstgeschwindigkeit
 7,5 KG (16,5 lbs)	 130 km/h (80 mph)

ACHTUNG: Die maximale Zuladung des verwendeten SW-MOTECH STREET-RACK / ADVENTURE-RACK Gepäckträgers darf nicht überschritten werden (siehe Anbauanleitung des Gepäckträgers)! Es gilt die vom Fahrzeughersteller genannte maximale Zuladung des Fahrzeugs!

ACHTUNG 

NICHT FÜR DEN OFFROAD-EINSATZ GEEIGNET!

ENGLISH - Thank you for choosing this premium product from SW-MOTECH. Please visit our webshop for additional information, such as application charts and PDF mounting instructions. Any other documents that may be required (e.g. ABE certifications), are also available for download at our webshop.

Installation and/or maintenance of this product require good technical understanding! For your own safety SW-MOTECH recommends having installation and/or servicing carried out by a specialist workshop! SW-MOTECH assumes no liability for damage caused by improper installation and/or maintenance work!

Carefully follow all the directions given in the mounting instructions and pay attention to all relevant information in the vehicle manual during assembly. Nonconformance can lead to vehicle damage or even endanger the driver! These mounting instructions are written based on our current state of knowledge. Legal requirements for accuracy do not exist.

This product was developed for vehicles in their factory setting. Compatibility with original accessory parts or other manufacturers' accessory parts is not guaranteed. Furthermore, BEFORE installing this product, make sure that all moving parts (e.g. the chain) are in the original state of maintenance. Installed accessories can change the driving behaviour and/or stability of your vehicle.

GENERAL INFORMATION

Observe the country-specific regulations concerning vehicle registration / operation as well as TÜV regulations if applicable. If required, register installed parts in the vehicle documents through an appropriate inspection authority.

PREPARATION: Read the mounting instructions carefully and make sure that all items of the parts list are included. Make sure that your vehicle is parked safely and cannot fall over. Turn off the engine and remove the ignition key. Let the motor / exhaust cool off if necessary. Disconnect the vehicle battery when working on the electrical system. Use appropriate tools. Have another person to help you.

FUNCTION CHECK: This is a universal product. For this reason make sure BEFORE the first use, that the product can be fixed properly and used without problems with your vehicle type. After fixation also make sure that no moving parts are obstructed and the function of the vehicle is not hindered in any way. Lamps as taillight and turn signals must not be limited in their function. Cables and hoses must not rub and/or be pinched. Before starting to ride, perform a comprehensive check of all functions.

PRODUCT SPECIFIC INFORMATION

ATTENTION: Riding with this product may affect the motorcycles driving and braking performance!

ATTENTION: Before riding and at each stop (every 200 km) check proper fixation of the product!

Maximum Load	Maximum Speed
 7,5 KG (16,5 lbs)	 130 km/h (80 mph)

ATTENTION: The maximum load of the used SW-MOTECH STREET-RACK / ADVENTURE-RACK must not be exceeded (refer mounting instructions of the rack)! The maximum vehicle load specified by the manufacturer must not be exceeded!

ATTENTION 

NOT FOR OFFROAD-USE!

Konfektionierung durch / Packed by:

Datum der Konfektionierung / Date of packaging:



SW-MOTECH GmbH & Co. KG
Ernteweg 8/10
35282 Rauschenberg
Germany

Tel. / phone + 49 (0)6425 / 8168 - 050
Fax / fax + 49 (0)6425 / 8168 - 10
info@sw-motech.com
www.sw-motech.com

STÜCKLISTE / PARTS LIST

Schritt Step	Nr. No.	Art.-Nr. / Bezeichnung * Item No. / Description *	Artikel	Part	Anzahl ** Quantity **	N-m ***														
			<i>Beide Varianten</i>	<i>Both variants</i>																
1	(1)		URBAN ABS Topcase	URBAN ABS top case	1 / 1															
	(2)	BC.ZUB.00.105.30000	Wasserdichte Innentasche	Waterproof inner bag	1 / 1															
	(3)	BC.LOC.00.001.10200/B	Motorradtaschen-Schloss	Lock for motorcycle luggage	1 / 1															
		<i>BC.HTA.00.677.21000</i>	<i>URBAN ABS Topcase für STREET-RACK</i>	<i>URBAN ABS top case for STREET-RACK</i>																
3	(4)	BC.HTA.00.677.500.01	Verschlussystem	Locking System	1 / 1															
	(5)	M5 x 12; ISO 7380	Linsenkopfschrauben; schwarz	Lenshead Screws; black	6 / 6	2,5														
	(6)	∅ 5,3; DIN 9021	Unterlegscheibe; Edelstahl	Washer; stainless steel	6 / 6															
	(7)	M5; DIN 985	Mutter, selbstsichernd; Edelstahl	Lock Nut; stainless steel	6 / 6															
7	(8)	HTA.00.864.500.07	Diebstahlsicherung	Anti-Theft Device	1 / 1															
	(9)	4,5 x 16	Linsenkopfschraube, gewindefurchend	Lenshead Screw, self-tapping	4 / 4	2,5														
		<i>BC.HTA.00.677.22000</i>	<i>URBAN ABS Topcase als Verzurrvariante</i>	<i>URBAN ABS top case as lashing variation</i>																
3	(4)	BC.HTA.00.677.900.01	Schaumgummiboden	Foam Rubber Base	1 / 1															
	(5)	M5 x 12; ISO 7380	Linsenkopfschrauben; schwarz	Lenshead Screws; black	6 / 8	2,5														
	(6)	∅ 5,3; DIN 9021	Unterlegscheibe; Edelstahl	Washer; stainless steel	6 / 6															
6	(7)	HTA.00.864.012	Abdeckplatte	Cover Plate	1 / 1															
	(8)	M5 x 12; ISO 7380	Linsenkopfschrauben; schwarz	Lenshead Screws; black	2 / 8	2,5														
	(9)	∅ 11 / ∅ 6 / h 4	Distanzbuchse; Kunststoff	Spacer; plastic	2 / 2															
	(10)	KEK.00.M8.ISK	Kunststoffkappe; schwarz	Plastic Cap; black	2 / 2															
7	(11)	BC.ZUB.00.097.30000	Schlaufgurt-Set (4 Stück)	Loop Strap Set (4 pieces)	1 / 1															
	(12)	BC.ZUB.00.004.30000	Verzurrösen-Set (2 Stück)	Lashing Eye Set (2 pieces)	1 / 1															
8.8	Regelgewinde / Coarse Thread ∅			M4	M5	M6	M8	M10	M12	10.9	Regelgewinde / Coarse Thread ∅			M4	M5	M6	M8	M10	M12	
	Stahl FK 8.8 / Steel CL 8.8			N-m	2,8	5,5	9,6	23	46	79	Stahl FK 10.9 / Steel CL 10.9			N-m	4,1	8,1	14	34	67	115

* Alle Maßangaben in Millimeter. - ** Der zweite Wert gibt die Gesamtanzahl des jew. Artikels in der Lieferung an.
 *** **Keine Anzugsmomentvorgabe: Verwenden Sie das vom Fzg.-Hersteller definierte Anzugsmoment!** Das Standard-Anzugsmoment der Tabelle kann verwendet werden, wenn es den Fzg.-Hersteller-Vorgaben entspricht.

* All measurements in millimeters. - ** The second number indicates the total quantity of the part in the delivery.
 *** **No torque specifications: Use the torque defined by vehicle manufacturer!** The standard torque in this table can be used as long as it is within the vehicle manufacturer's specifications.

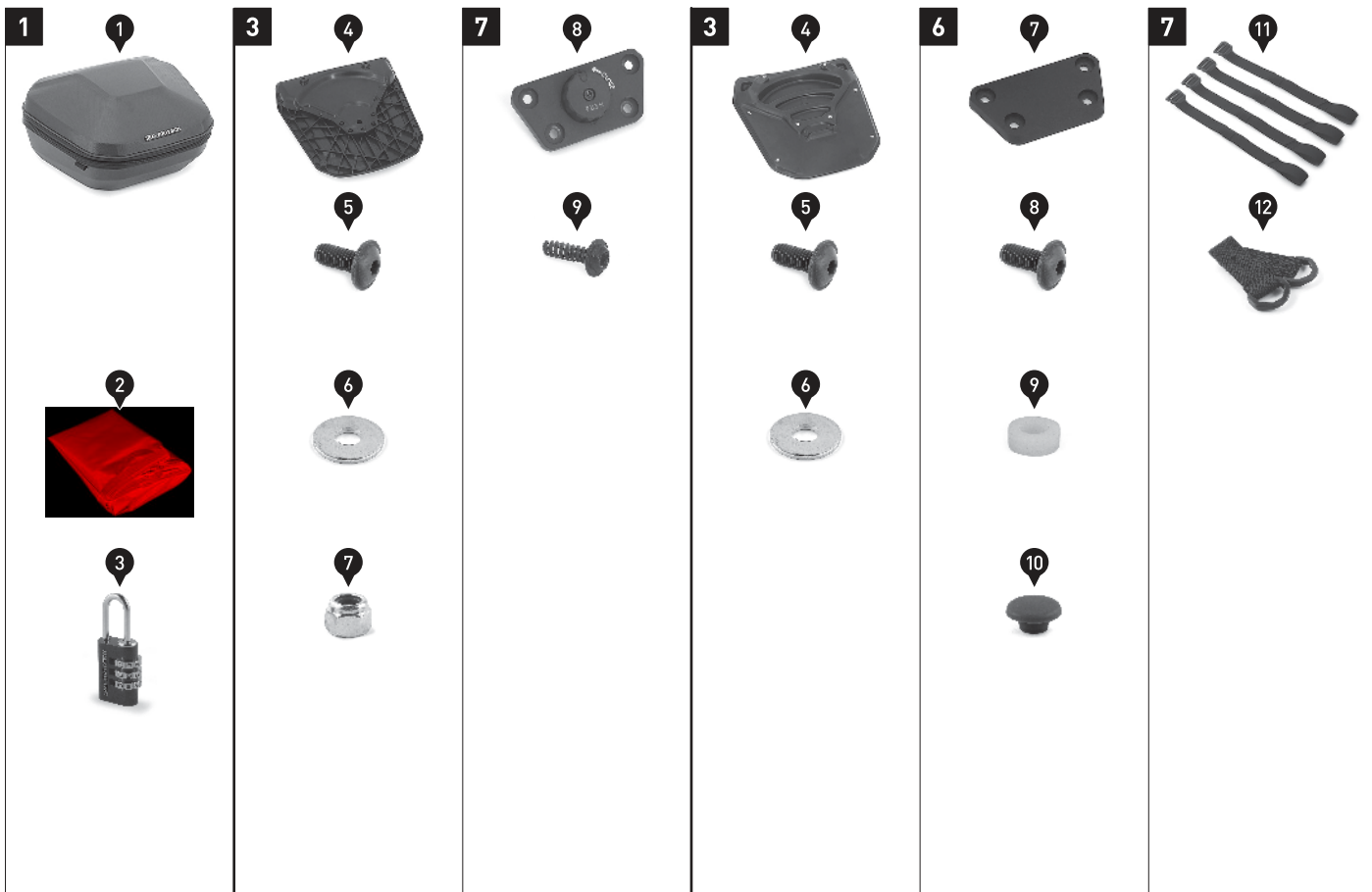

Seite 3 – 4:
URBAN ABS Topcase für
STREET-RACK

Schritt [1]: Öffnen Sie den Deckel und den innenliegenden Reißverschluss des Topcase (1).
Schritt [2]: Klappen Sie die Innenverkleidung nach oben.
Schritt [3]: Verschrauben Sie das Verschlusssystem (4) unter dem Topcase (1). Achten Sie auf die Position des Verschlusshebels (geschlossen). Ziehen Sie die Schrauben wie in der Stückliste vorgegeben an.

Page 3 – 4:
URBAN ABS top case for
STREET-RACK

Step [1]: Open the lid and inner zipper of the top case (1).
Step [2]: Flip up the inner lining.
Step [3]: Attach the locking system (4) under the top case (1). Pay attention to the position of the locking lever (closed). Tighten the screws as specified in the parts list.

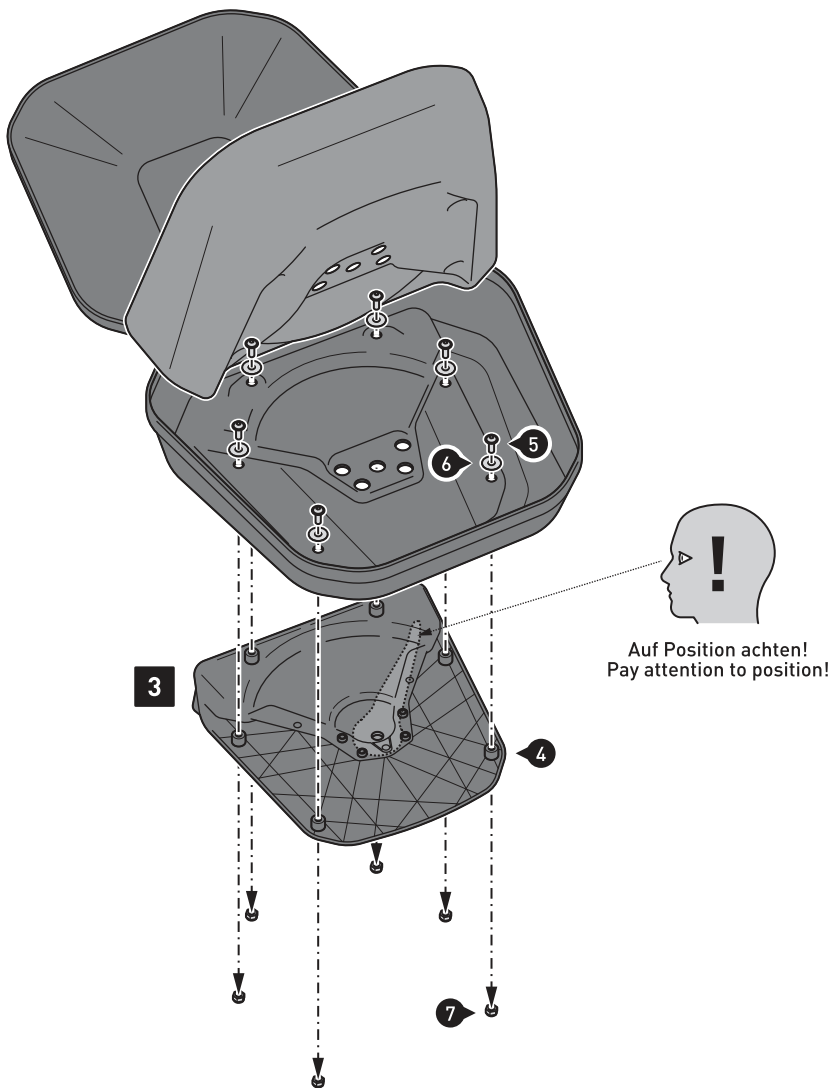
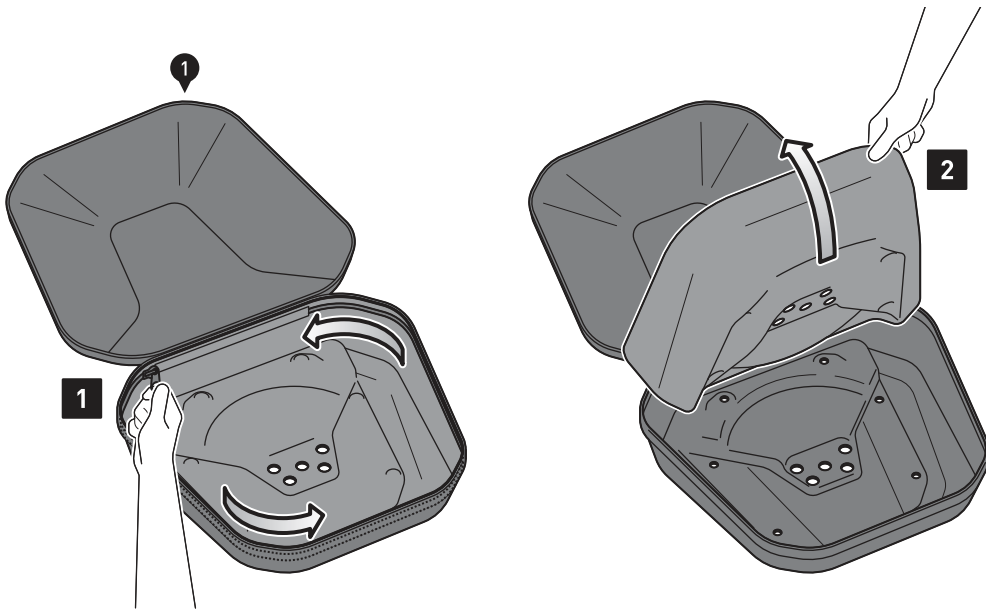



Schritt [4]: Klappen Sie die Innenverkleidung nach unten.
Schritt [5]: Schließen Sie den innenliegenden Reißverschluss des Topcase (1).
Schritt [6]: Drehen Sie den Sicherungsknopf der Diebstahlsicherung (8) in die geschlossene Position.
Schritt [7]: Verschrauben Sie die Diebstahlsicherung (8) im Topcase (1). Ziehen Sie die Schrauben wie in der Stückliste vorgegeben an.

BEFESTIGUNG AM STREETRACK GEPÄCKTRÄGER

Schritt [8]: Drehen Sie den Sicherungsknopf in die geöffnete Position.
Schritt [9]: Drücken Sie den Verschlusshebel in die geöffnete Position.
Schritt [10]: Schieben Sie das Verschlusssystem (4) mit den beiden Haken in die Öffnungen Ihres STREET-RACK Gepäckträgers [separat erhältlich].
Schritt [11]: Drücken Sie das Topcase (1) leicht nach unten ...
Schritt [12]: ... und schließen Sie den Verschlusshebel. Achten Sie auf das deutliche Einrastgeräusch.
Schritt [13]: Sichern Sie das Topcase mit dem Sicherungsknopf der Diebstahlsicherung (8) gegen Diebstahl und überprüfen Sie den festen Sitz am Fahrzeug.
TIPP: Wir empfehlen, den Sicherungsknopf der Diebstahlsicherung (8) während der Fahrt immer in der abgeschlossenen Position zu belassen.

Step [4]: Flip down the inner lining.
Step [5]: Close the inner zipper of the top case (1).
Step [6]: Turn the locking button of the anti-theft device (8) to the closed position.
Step [7]: Attach the anti-theft device (8) inside the top case (1). Tighten the screws as specified in the parts list.

MOUNTING TO THE STREET-RACK

Step [8]: Turn the locking button into the open position.
Step [9]: Push the locking lever into the open position.
Step [10]: Slide the locking system (4) with the two hooks into the openings of your STREET-RACK [sold separately].
Step [11]: Press the top case (1) slightly down ...
Step [12]: ... and close the locking lever. Pay attention to the audible snap sound.
Step [13]: Secure the top case via locking button of the anti-theft device (8) against theft and check the proper fit on the vehicle.
TIP: We recommend leaving the locking button of the anti-theft device (8) in the closed position during the ride.



Auf Position achten!
Pay attention to position!

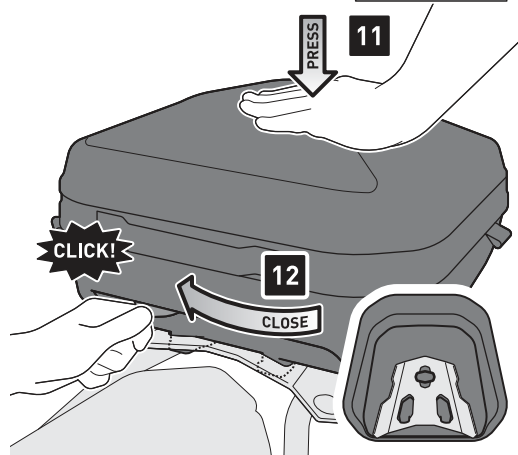
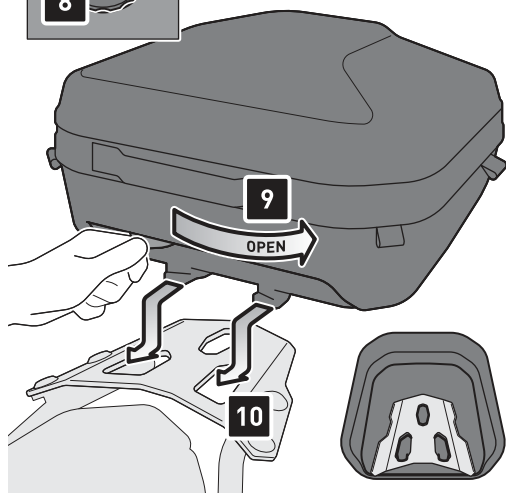
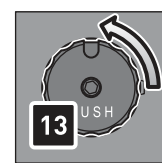
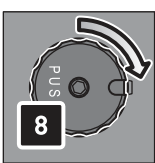
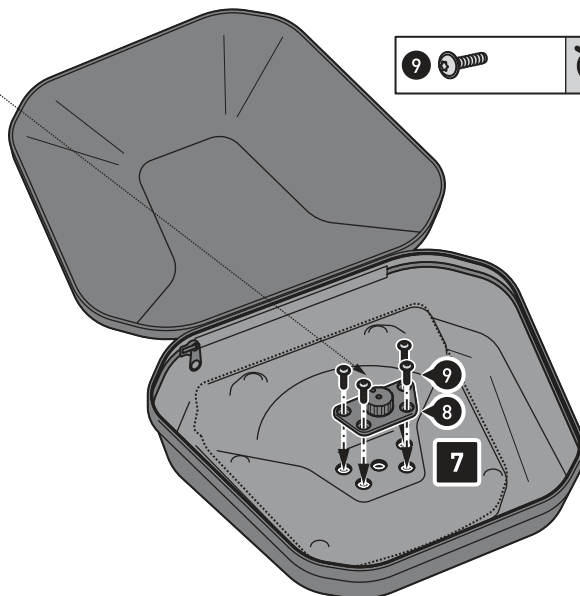
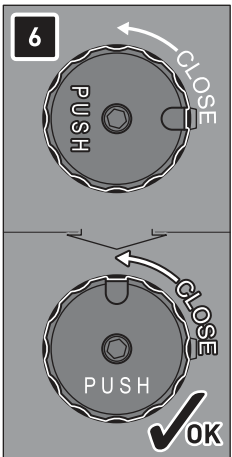

Seite 5 – 7:
URBAN ABS Topcase als
Verzurrvariante

- Schritt [1]:** Öffnen Sie den Deckel und den innenliegenden Reißverschluss des Topcase (1).
- Schritt [2]:** Klappen Sie die Innenverkleidung nach oben.
- Schritt [3]:** Verschrauben Sie den Schaumgummiboden (4) unter dem Topcase (1). Ziehen Sie die Schrauben wie in der Stückliste vorgegeben an.
- Schritt [4]:** Klappen Sie die Innenverkleidung nach unten.
- Schritt [5]:** Schließen Sie den innenliegenden Reißverschluss des Topcase (1).

Page 5 – 7:
URBAN ABS top case as
lashing variation

- Step [1]:** Open the lid and inner zipper of the top case (1).
- Step [2]:** Flip up the inner lining.
- Step [3]:** Attach the foam rubber base (4) under the top case (1). Tighten the screws as specified in the parts list.
- Step [4]:** Flip down the inner lining.
- Step [5]:** Close the inner zipper of the top case (1).

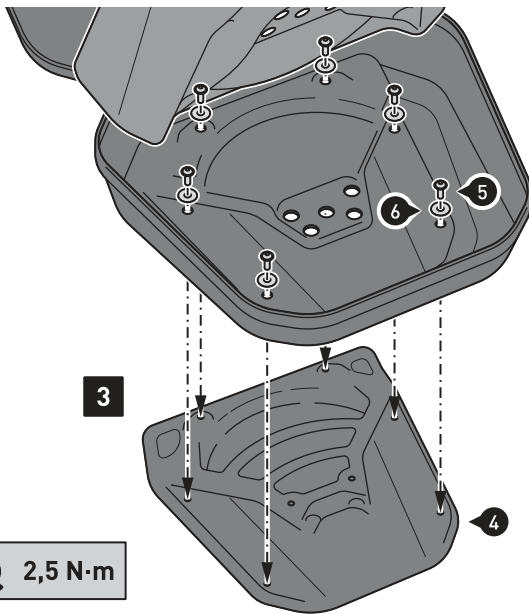

5 2,5 N-m





8 2,5 N·m

Schritt [6]: Verschrauben Sie die Abdeckplatte (7) im Topcase (1). Ziehen Sie die Schrauben wie in der Stückliste vorgegeben an.

BEFESTIGUNG AM FAHRZEUG

Schritt [7]: Verschlaufen Sie ZWEI Schlaufgurte (11) beidseitig an geeigneten und belastbaren Befestigungspunkten im Heckbereich des Fahrzeugs [z. B. Gepäckhaken etc.]. Verschlaufen Sie anschließend ZWEI Schlaufgurte (11) beidseitig an geeigneten und belastbaren Befestigungspunkten des Fahrzeugs [z. B. Fußrastenaufnahme, Fahrzeugrahmen etc.].

FUNKTIONSKONTROLLE (UNBEDINGT BEACHTEN)

ACHTUNG: Achten Sie nach der Befestigung darauf, dass kein Schlaufgurt mit heißen und beweglichen Teilen des Fahrzeugs in Berührung kommen kann. Achten Sie des Weiteren darauf, dass alle Schlaufgurte mindestens 15 cm Abstand zu heißen Teilen sowie dem heißen Abgasstrom des Auspuffs haben. Federn Sie zu diesem Zweck nach erfolgter Montage das Fahrzeug mehrere Male im Stand voll durch.

Step [6]: Attach the cover plate (7) inside the topcase (1). Tighten the screws as specified in the parts list.

FIXATION TO THE VEHICLE

Step [7]: On both sides entangle TWO loop straps (11) to appropriate and reliable attachment points in the rear area of the vehicle (e.g. luggage hook etc.). Then entangle on both sides TWO loop straps (11) to appropriate and reliable attachment points of the vehicle (e.g. vehicles frame, footrest mounts etc.).

FUNCTION CHECK (MUST BE OBSERVED)

ATTENTION: All loop straps must not contact any hot or moving parts of the vehicle. All loop straps should also remain 15 cm away from hot parts of the vehicle and remain clear of the exhaust stream. For this reason compress the suspension fully several times with your vehicle stationary.





Schritt [8]: Befestigen Sie nun die Hakenschnallen der VIER Schlaufgurte (11) beidseitig an den in der Zeichnung gezeigten Schlaufen des Topcase (1). Ziehen Sie alle Befestigungsgurte an, bis das Topcase (1) zentriert und fest am Fahrzeug befestigt ist.

Schritt [9]: Sichern Sie die Überlängen der Schlaufgurte (11) mit den Gummischlaufen gegen Flattern.

Schritt [10]: Überprüfen Sie den festen Sitz des Topcase.

Step [8]: Attach the hook buckles of the loop straps (11) on both sides of the marked loops of the top case (1), as shown in the drawing. Tighten all loop straps until the top case (1) is centered and securely fastened to the vehicle.

Step [9]: Secure the overlength of the loop straps (6) with the rubber loops against flapping.

Step [10]: Check the proper fit of the top case.





FEUCHTIGKEITSSCHUTZ

Verwenden Sie die beiliegende wasserdichte Innentasche (2), um Ihr Gepäck vor Feuchtigkeit zu schützen.

MOISTURE PROTECTION

Use the included waterproof inner bag (2) to protect your luggage from moisture.



SICHERUNG

Verriegeln Sie die Puller des geschlossenen Reißverschlusses mit dem beiliegenden Schloss (3).

SECURITY

Lock the closed zipper with the included lock (3).



BELADUNG

ACHTUNG: Achten Sie darauf, niemals scharfkantige, spitze oder ähnliche Gegenstände zu verstauen, welche Verletzungen an Personen bzw. Beschädigungen am Fahrzeug/Topcase verursachen könnten!

Volumenerweiterung: Öffnen Sie den umlaufenden Reißverschluss. Der Öffnungswinkel kann für einen festen Sitz über die angebrachten Riemen reguliert werden.



LOADING

ATTENTION: Never store pointy or sharp-edged objects, which could cause injury to persons or damage to the vehicle/top case.

Volume expansion: Open the revolving zipper. For a tight fit the opening angle can be adjusted via the attached straps.



ACHTUNG: Oberflächenmaterialien können bei längerer und intensiver Sonneneinstrahlung und Umwelteinflüssen (z. B. SMOG, saurer Regen, etc.) Farbveränderungen (Ausbleichen) unterliegen! Dafür übernimmt SW-MOTECH keine Haftung!

ATTENTION: Surface materials can experience color changes or fading when exposed to direct sunlight for extended periods of time and by environmental factors (e.g., SMOG, acid rain, etc.)! SW-MOTECH assumes no liability for this!



PFLEGE

Verwenden Sie zur Reinigung NUR eine weiche Textilbürste, ein Tuch oder Schwamm und warme Seifenlauge! Spülen Sie anschließend mit klarem Wasser nach.

Verwenden Sie KEINE scharfen Reinigungsmittel, raue Putzutensilien oder einen Hochdruckreiniger! Reinigen Sie das Topcase unbedingt nach Winterfahrten, um Schäden durch das Salz zu vermeiden.



CARE

For cleaning use ONLY a soft textile brush, cloth or sponge and warm soapy water! Rinse with clean water.

Do NOT use strong cleaning agents, rough cleaning tools or high pressure washer! Clean the top case after riding in salty conditions, to avoid damage from salt.