



FITTING INSTRUCTIONS for...

- KTM 1290 Super Adventure S ('2021-on)
- KTM 1290 Super Adventure R ('2021-on)

www.barkbusters.net

Preparation

Remove original handguards and bar end weights if fitted.

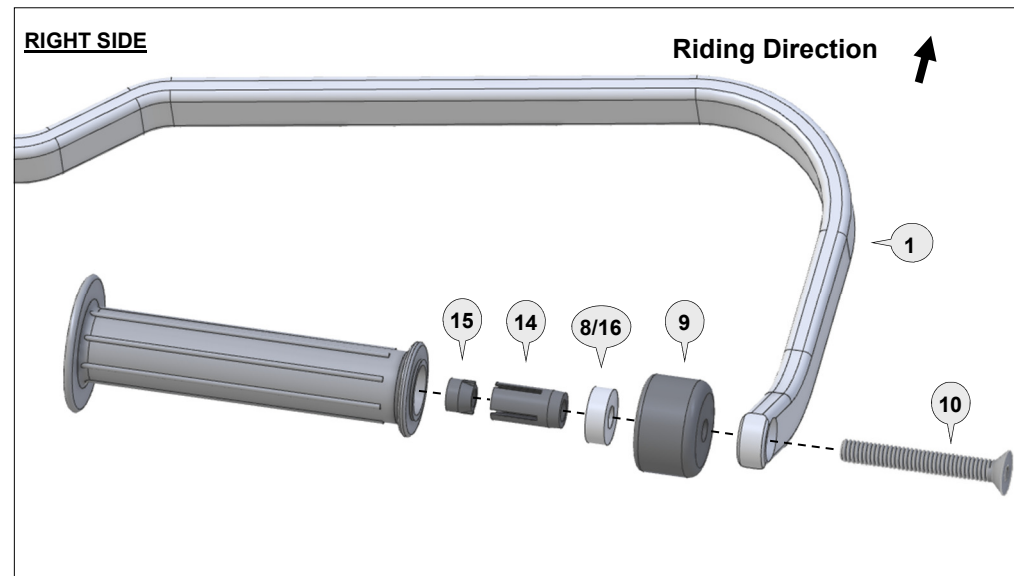
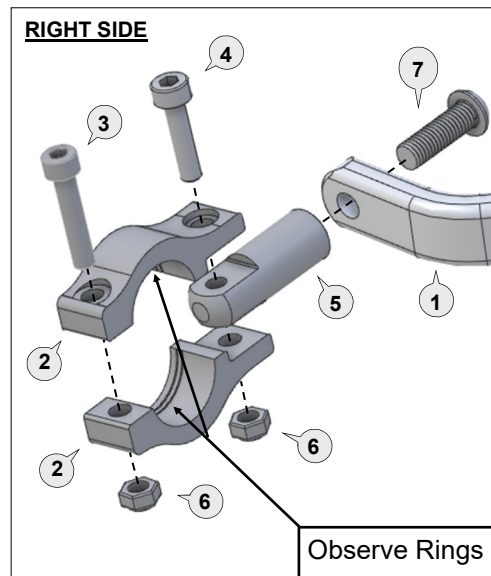
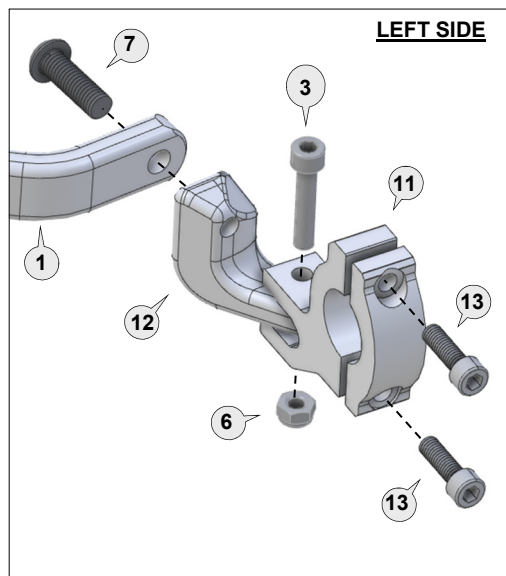
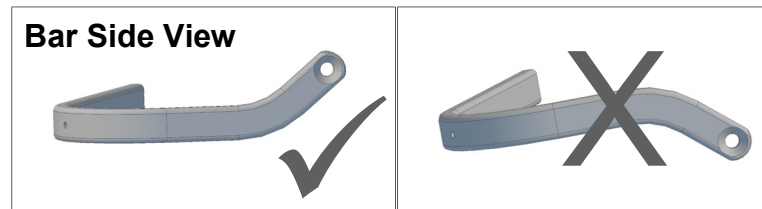













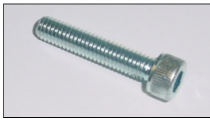

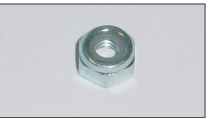
Installation

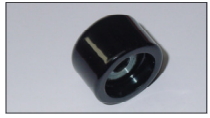
For Left Side:

- Loosely assemble the clamp (11) to the handlebar as per diagram.
- Attach the handguard backbone (1) with applicable parts to the handlebar end using the 10mm spacer (8) and also to the clamp connector (12).
- Position backbone so it is horizontal when viewed from the side.
- Tighten all bolts to the specified torque (over page) in the following order: (10), (7), (13) then (3).

For Right Side:

- Loosely assemble the clamp (2) to the handlebar as per diagram.
- Attach the handguard backbone (1) with applicable parts to the handlebar end using the 7mm spacer (16) and also to the clamp connector (5).
- Position backbone so it is horizontal when viewed from the side. Please note that the brake fluid reservoir might need to be bent upward by 1 or 2mm.
- Tighten all bolts to the specified torque (page 2) in the following order: (10), (7), (4) then (3).

<p>1 Aluminium Bar</p>  <p>PN: BAR-V-057 Pcs. Left/Right Pair</p>	<p>2 Clamp Saddles</p>  <p>PN: CS-02 Pcs. 1 pairs</p>	<p>3 Socket Head Bolt 30mm</p>  <p>PN: M6X30SHCSZP Pcs. 2</p>	<p>4 Socket Head Bolt 25mm</p>  <p>PN: M6X25SHCSZP Pcs. 1</p>	<p>5 Clamp Connector</p>  <p>PN: CP1 Pcs. 1</p>	<p>6 Nylock Nut 6mm</p>  <p>PN: M6LN Pcs. 3</p>	<p>7 Button Head Bolt 25mm</p>  <p>PN: M8X25BHCSZP Pcs. 2</p>	<p>8 Spacer (10mm)</p>  <p>PN: BSSRT10 Pcs. 1</p>
<p>9 Bar End Cap</p>  <p>PN: BEW35 Pcs. 2</p>	<p>10 Flat Head Bolt 65mm</p>  <p>PN: M8X65FHCSZP Pcs. 2</p>	<p>11 Multi Fit Clamp LEFT</p>  <p>PN: MFC-L Pcs. 1 set</p>	<p>12 Connector LEFT</p>  <p>PN: CP8-L Pcs. 1</p>	<p>13 Socket Head Bolt 20mm</p>  <p>PN: M6X20SHCSZP Pcs. 2</p>	<p>14 Bar End Expander</p>  <p>PN: BBE14A Pcs. 2</p>	<p>15 Nut 12mm - Two wings</p>  <p>PN: NUT12 Pcs. 2</p>	<p>16 Spacer (7mm)</p>  <p>PN: SP07-20-08 Pcs. 1</p>

Recommended Torque Settings	
M6	10 Nm (7.4 lbf ft)
M8	20 Nm (14.8 lbf ft)

CAUTION:

Installation of the handguard is safety-relevant work and can be complicated. We recommend the installation be performed by a motorcycle service technician. Rideworx accepts no liability for damages caused by improper mounting. All screws, bolts and nuts, including all replacement hardware provided by Rideworx, should be tightened to the torque specified in the table. After the first 50km of riding check all screws, bolts and nuts are tightened to the correct torque. We recommend a medium strength liquid thread lock product on all fasteners.

WARNING:

It is important there is a working clearance (approx 3mm) between the throttle grip end and the handguard to ensure a free closing throttle. Check operation of all handlebar controls, specifically the throttle, front brake, kill switch and clutch to ensure they are operating correctly and are in accordance with the OEM specifications. Do not ride the motorcycle if any controls are not operating correctly. Check periodically that all bolts are tight. Please note that all Rideworx test fitment are done on stock motorcycles with factory standard handle bar, windscreen, etc. in there original positions.

Disclaimer:

A failure to follow these fitting instructions could cause serious injury, death or property damage. These handguards are intended solely for use with motorcycles/ATV/snowmobiles/scooters that have not been modified. They are not designed to prevent injury or death while riding or in an accident or crash. The user must ensure that all controls are free of the handguards every time that they ride. By installing and/or using this product you acknowledge that you accept these terms and have followed the fitting instructions.

Personalise Your Protection
Guard options sold separately

JET JET-003
VPS VPS-003
Storm STM-003
CARBON BCF-003



Email: info@barkbusters.net

[@BARKBUSTERSHANDGUARDS](https://www.instagram.com/barkbustershandguards)



Barkbusters
www.barkbusters.net

Esempio di aggancio
delle plastiche VPS

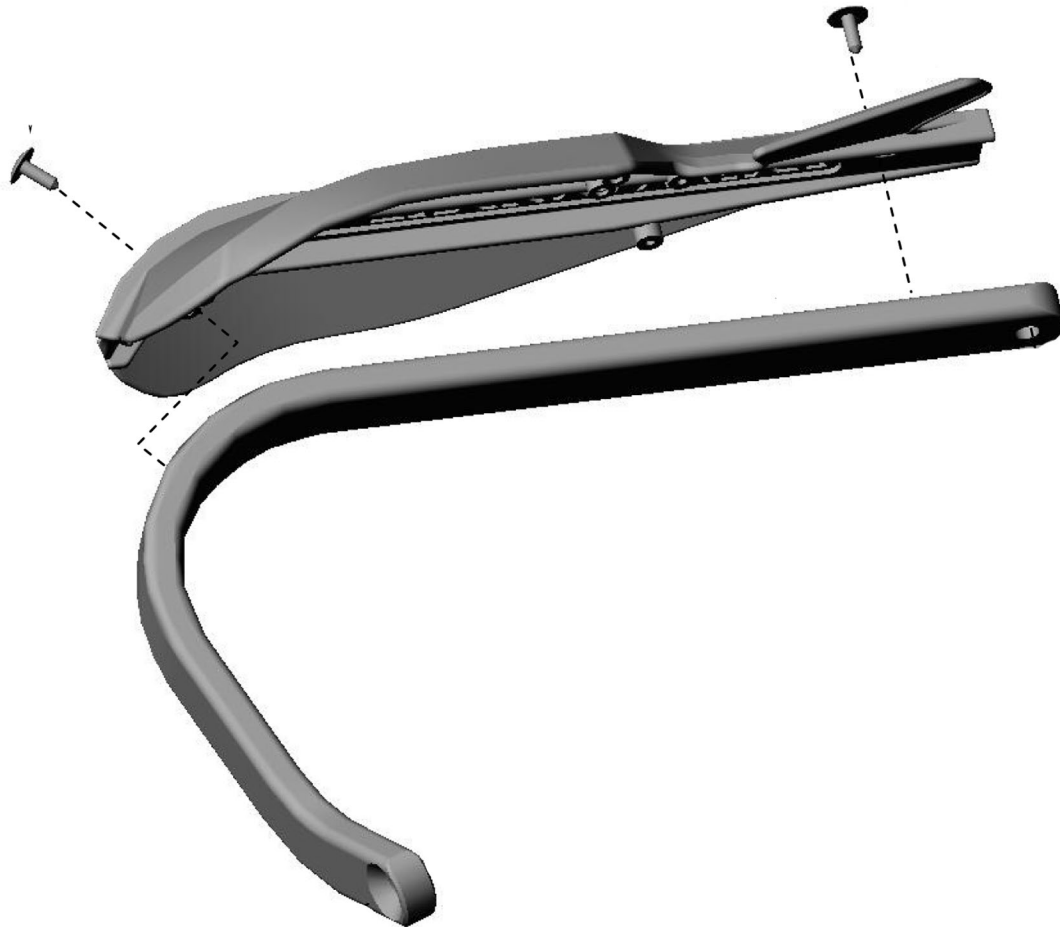

Phone: +61 (0)2 4271 8244
Email: info@barkbusters.net