

ANBAUANLEITUNG

mounting instructions • instructions de montage • instrucciones de montaje • istruzioni di montaggio

KFT.22.995.60100/B

beinhaltet • contains • contient • contiene • contiene

KFT.22.995.30001/B

KFT.00.152.35200

BC.HTA.00.675.12000/B

QLS.00.095.10001/B

Numero di articolo: KFT.22.995.30001/B

Revisione: 00 · Data: 11 - 2022

Telaio laterale PRO

 ~ 1 h.

 FACILE     DIFFICILE

ITALIANO - Grazie per aver scelto questo prodotto premium di SW-MOTECH. Per ulteriori informazioni (ad esempio per la compatibilità con i vari modelli), è possibile visitare il nostro shop online. I documenti necessari (ad esempio il permesso operativo generale) sono disponibili per il download.

Si prega di leggere attentamente le avvertenze di sicurezza e le istruzioni per il montaggio prima di montare e utilizzare il prodotto, al fine di evitare eventuali lesioni e danni. Conserva queste istruzioni per il montaggio come riferimento futuro.

Questo prodotto è stato sviluppato per veicoli in condizioni di fabbrica. La compatibilità con gli accessori originali o di altri produttori non può essere garantita.

Queste istruzioni per il montaggio sono state redatte in base alle nostre conoscenze attuali. Non sussistono pretese di correttezza giuridiche. Salvo errori ed omissioni. Ci riserviamo il diritto di apportare modifiche tecniche e di design. Copyright SW-MOTECH.

SIMBOLO DI SICUREZZA

 Questo simbolo di avvertenza è usato nelle presenti istruzioni di montaggio per segnalare pericoli mortali, rischio di lesioni o altri pericoli. Le parole "PERICOLO", "AVVERTENZA" o "ATTENZIONE" sono utilizzate con questo simbolo di avvertenza per trasmettere importanti istruzioni di sicurezza e informazioni relative al montaggio e all'uso di questo prodotto. Queste parole, utilizzate insieme al simbolo di avvertenza, significano:

 **PERICOLO:** indica una situazione di pericolo che, se non evitata, può causare morte o lesioni gravi!

 **AVVERTENZA:** indica una situazione di pericolo che, se non evitata, può causare morte o lesioni gravi!

 **ATTENZIONE:** indica una situazione di pericolo che, se non evitata, può provocare lesioni lievi o di entità moderata!

 **AVVISO:** indica informazioni importanti che non riguardano il rischio di morte o di lesioni (riguardano unicamente il rischio di danni materiali)!

INFORMAZIONI GENERALI

 **AVVERTENZA:** il montaggio e/o la manutenzione di questo prodotto richiedono competenze tecniche avanzate, strumenti adeguati e una buona conoscenza dell'uso e delle caratteristiche della strumentazione di montaggio. Per la vostra sicurezza, SW-MOTECH raccomanda di far eseguire il montaggio e/o la manutenzione presso un'officina specializzata e certificata.

 **AVVERTENZA:** se si decide di installare questo prodotto in autonomia, leggere attentamente le istruzioni di montaggio prima del montaggio e dell'uso e seguirle attentamente per evitare lesioni gravi o mortali. Durante il montaggio e l'uso, seguire anche tutte le istruzioni pertinenti contenute nel manuale del veicolo. SE NON SI COMPRENDONO TALI ISTRUZIONI, ANCHE SOLO IN PARTE, O SE SONO NECESSARI CHIARIMENTI, NON CERCARE DI MONTARE IL PRODOTTO IN AUTONOMIA, SENZA CHIEDERE IL SUPPORTO DI SW-MOTECH!

PREPARAZIONE: leggere attentamente le istruzioni per il montaggio e assicurarsi che siano disponibili tutti i componenti contenuti nella lista.

 **ATTENZIONE:** assicurarsi che il veicolo sia perfettamente fermo. Spegner il motore e togliere la chiave. Se necessario, lasciar raffreddare il motore/scarico. Scollegare la batteria quando si interviene sull'impianto elettrico. Usare esclusivamente strumenti idonei e indossare sempre occhiali e guanti protettivi durante le operazioni di montaggio e manutenzione. Chiedere aiuto a una seconda persona durante le fasi di montaggio e manutenzione.

MONTAGGIO: tutti i componenti e i collegamenti rimossi dal veicolo devono essere reinstallati secondo le specifiche del produttore del veicolo o sostituiti con componenti e attrezzatura forniti da SW-MOTECH.

 **AVVERTENZA:** fissare tutte le filettature con frenafili liquido a media resistenza, se non diversamente specificato.

 **PERICOLO:** le coppie di serraggio non definite da SW-MOTECH devono essere richieste al costruttore del veicolo o a un'officina certificata.

CONTROLLO DI FUNZIONALITÀ: dopo il montaggio, accertarsi che non ci siano parti mobili bloccate e che il funzionamento del veicolo non sia disturbato. I cavi e i tubi flessibili non devono essere danneggiati e/o schiacciati.

 **AVVERTENZA:** eseguire un controllo completo delle funzioni prima di mettersi alla guida. Controllare la coppia di serraggio di tutti i collegamenti e la tenuta del prodotto dopo i primi 50 km e in seguito regolarmente. Gli accessori montati possono modificare la maneggevolezza e la stabilità del veicolo.



SW-MOTECH GmbH & Co. KG
Ernteweg 7-10
35282 Rauschenberg
Germania



✉ info@sw-motech.com
🌐 www.sw-motech.com



Consultare i simboli e il loro significato nella sezione MONTAGGIO. Se nella sezione montaggio compare la sigla OEM, è necessario rispettare e applicare le specifiche del produttore del veicolo.



Per qualsiasi domanda, non esitare a contattare il nostro servizio clienti o i nostri distributori. Il nostro numero di telefono e l'elenco dei nostri distributori sono disponibili nel nostro shop online all'indirizzo:
www.sw-motech.com



Protezione delle mani: indossare un'adeguata protezione delle mani durante il montaggio e lo smontaggio.



Occhiali protettivi: Indossare occhiali protettivi durante il montaggio e lo smontaggio.



Cricchetto con prolunga: utilizzare questo strumento durante le operazioni di montaggio o smontaggio



Set di punte esagonali: utilizzare questo strumento durante il montaggio o lo smontaggio.



Usare un frenafili: indica che una filettatura deve essere rivestita con un frenafili liquido. H (ALTA): alta resistenza; M (MEDIA): media resistenza; L (BASSO): bassa resistenza.



Serraggio / rispetto delle specifiche sulla coppia di serraggio: indica la coppia di serraggio di una parte specificata da SW-MOTECH o dal produttore del veicolo (OEM).



Chiave a forchetta/chiave ad anello utilizzare questo strumento durante le operazioni di montaggio o smontaggio.























Non utilizzare il frenafili: segnala di non dover utilizzare il frenafili liquido in quel determinato punto.









Chiave dinamometrica: utilizzare questo strumento durante il montaggio o lo smontaggio.

ELENCO DELLE PARTI - LEGGI E CONSERVA LE ISTRUZIONI DI MONTAGGIO!

<p>2</p>	<p>1</p>  <p>KFT.22.822.001.11</p> <p> 2/2</p>	<p>2</p>  <p>M8 x 40; DIN 912</p> <p>SC.ST.08.040.48.912.109</p> <p> 4/4</p>	<p>3</p>  <p>KFT.05.440.007.11</p> <p> 4/4</p>	<p>4</p>  <p>M8 x 35; DIN 6912</p> <p>SC.ST.08.035.02.6912.088</p> <p> 4/4</p>	<p>5</p>  <p>ø 8,4; DIN 125</p> <p>US.ST.084.02.125</p> <p> 4/4</p>	<p>6</p>  <p>Ø 20 / Ø 8,4 / h 14,5</p> <p>DB.ST.0200.0084.0145.02</p> <p> 4/4</p>
-----------------	---	---	---	--	--	--

<p>3</p>	<p>7</p>  <p>KFT.06.525.005.11</p> <p> 1/1</p>	<p>8</p>  <p>M6 x 25; ISO 7380</p> <p>SC.ST.06.025.02.7380.109</p> <p> 3/3</p>	<p>9</p>  <p>Ø 20 / Ø 6,4 / h 5</p> <p>DB.ST.0200.0064.0050.02</p> <p> 1/1</p>	<p>10</p>  <p>M6; DIN 6927</p> <p>MU.ST.06.02.6927.08</p> <p> 3/3</p>
-----------------	---	---	---	---

<p>4</p>	<p>11</p>  <p>KFT.22.995.971.01.11</p> <p> 1/1</p>	<p>12</p>  <p>KFT.22.995.972.01.11</p> <p> 1/1</p>	<p>13</p>  <p>KFT.00.152.SV.8</p> <p> 1/1</p>
-----------------	--	--	---

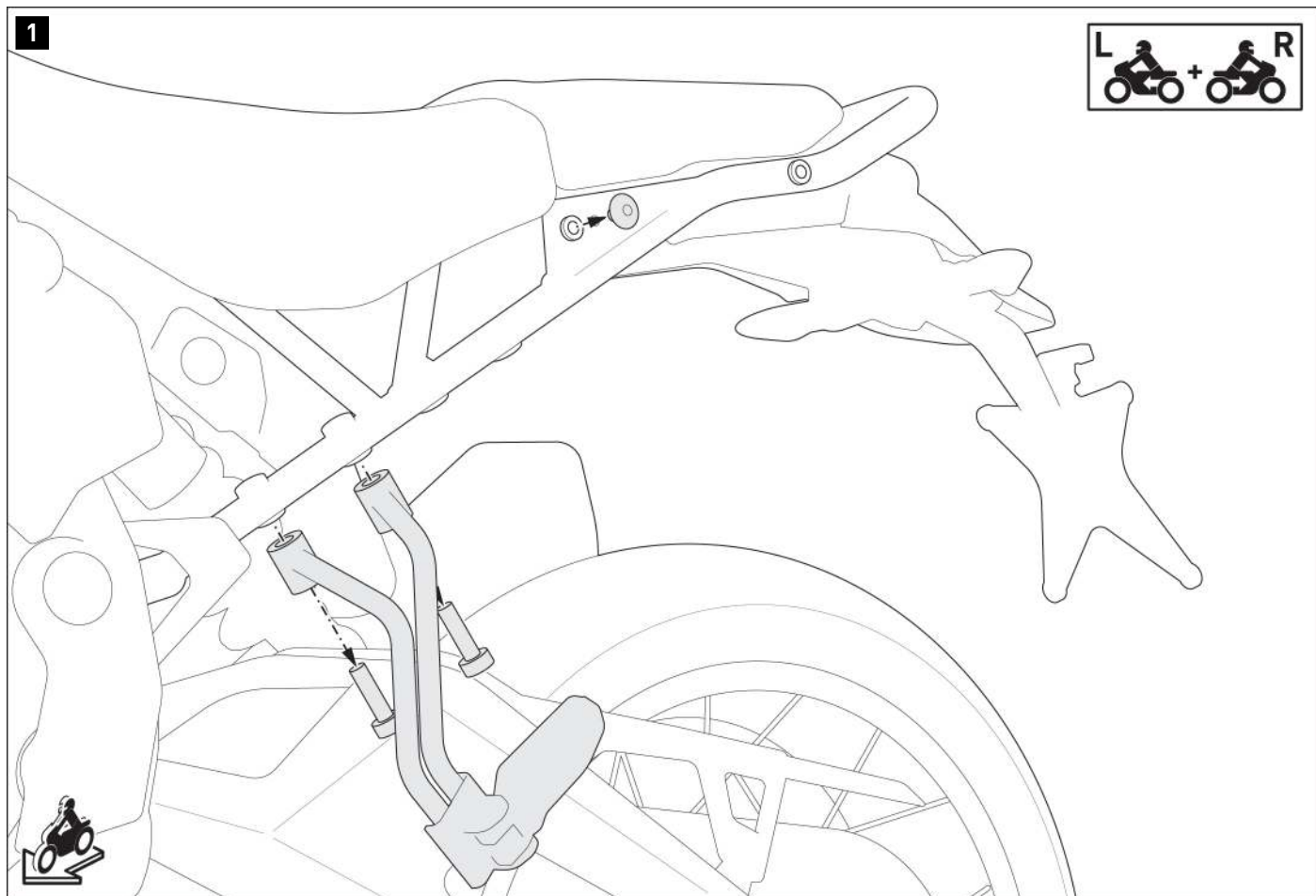

⚠AVVERTENZA: indossare sempre le protezioni per gli occhi e per le mani!
⚠AVVERTENZA: utilizzare sempre strumenti adeguati!

Rimuovere le viti indicate da entrambi i lati del veicolo e smontare le pedane passeggero.

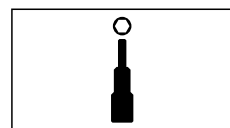
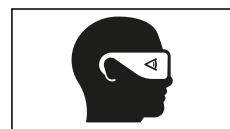

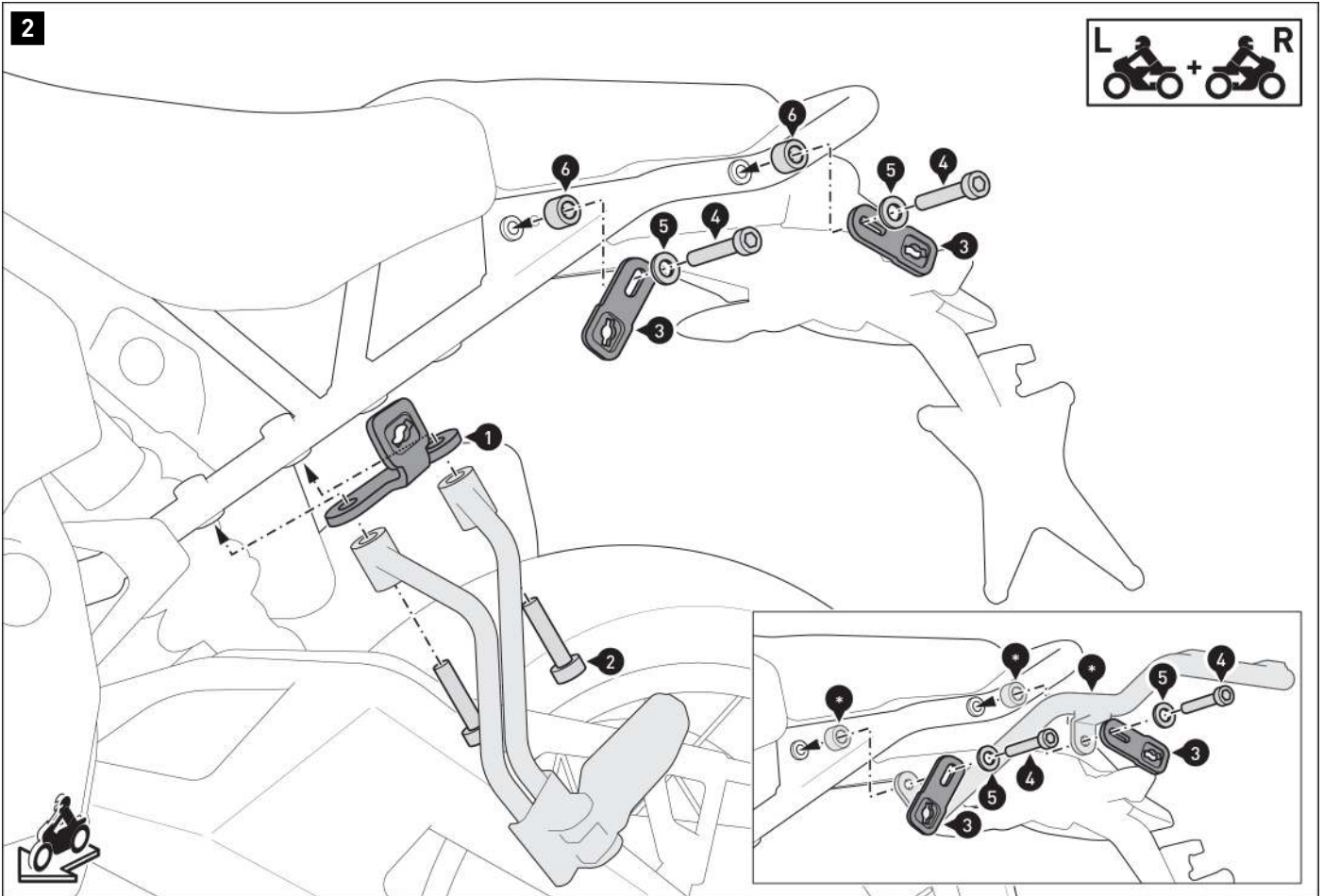

Avvitare le staffe di montaggio (1) alle pedane passeggero su entrambi i lati del veicolo.

⚠AVVERTENZA: usare un frenafiletto liquido!
Non serrare ancora le viti (2).

Avvitare le staffe di montaggio (3) alla parte posteriore del veicolo su entrambi i lati.

⚠AVVERTENZA: usare un frenafiletto liquido!
Non serrare ancora le viti (4).

⚠ *Avviso: per montare il telaio laterale insieme al portabagagli SW-MOTECH, utilizzare i distanziali del portapacchi (*) come indicato nel disegno dettagliato.*

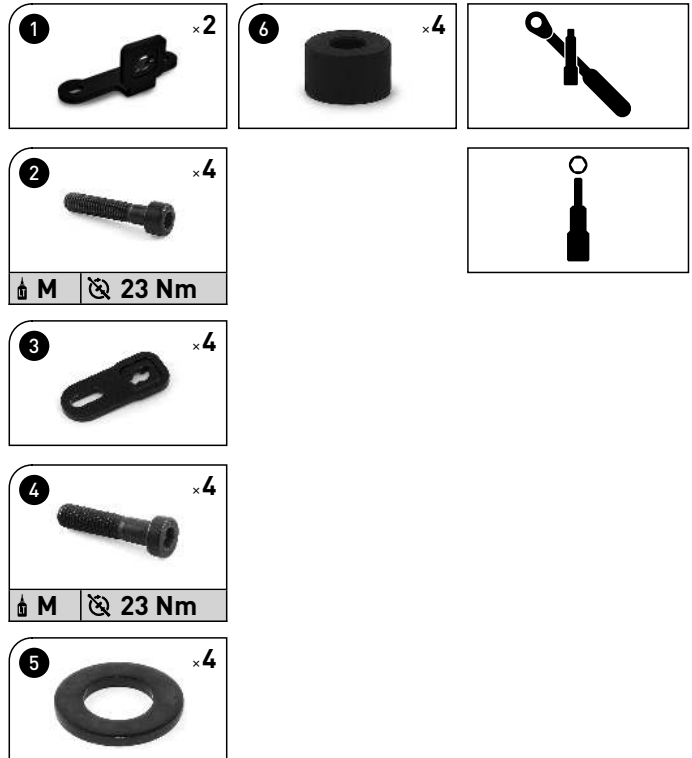

3

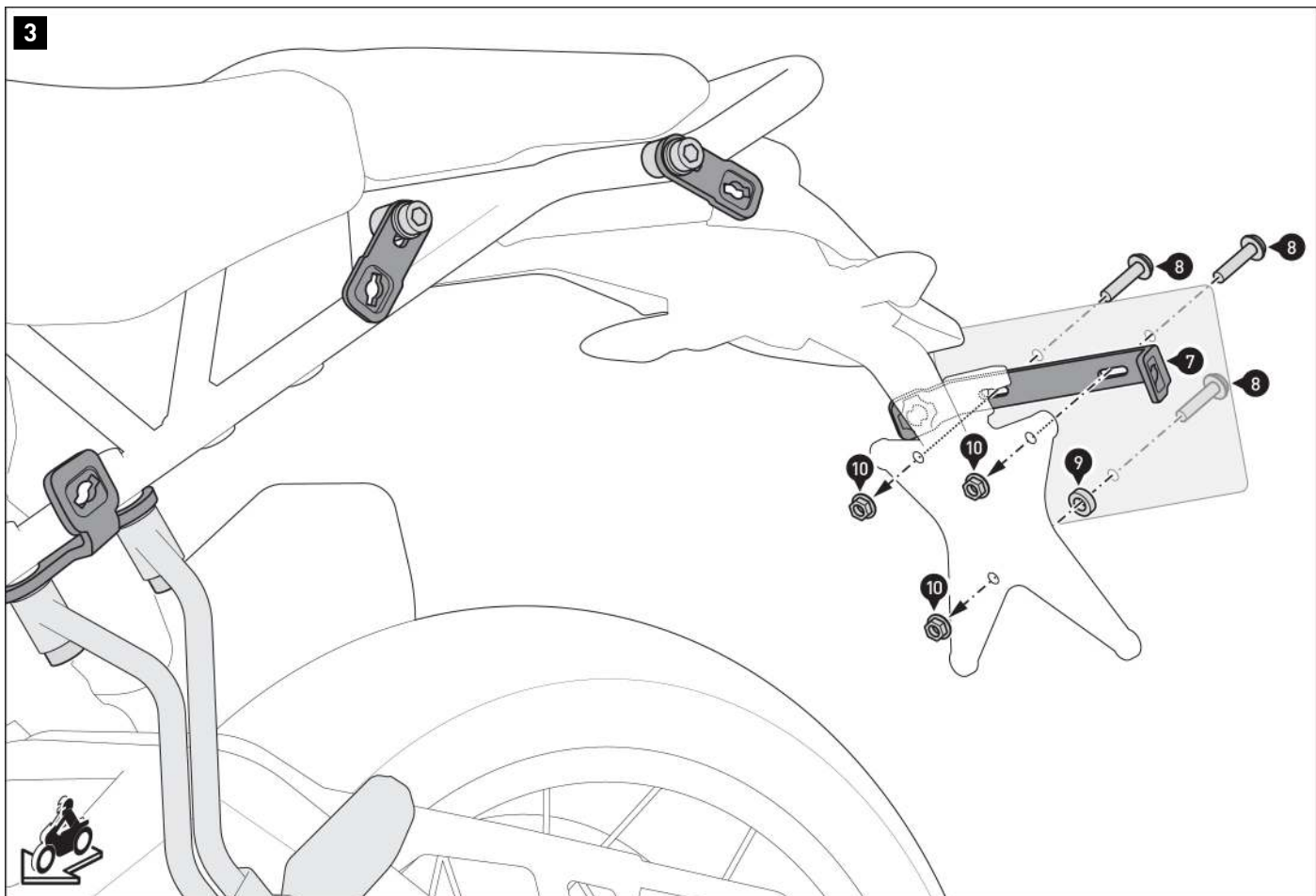

Avvitare il connettore a croce (7) alla targa sul portatarga.
Non serrare ancora le viti.



9,6 Nm

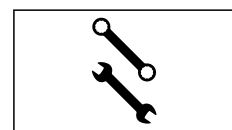
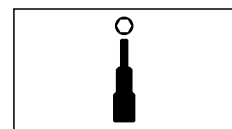

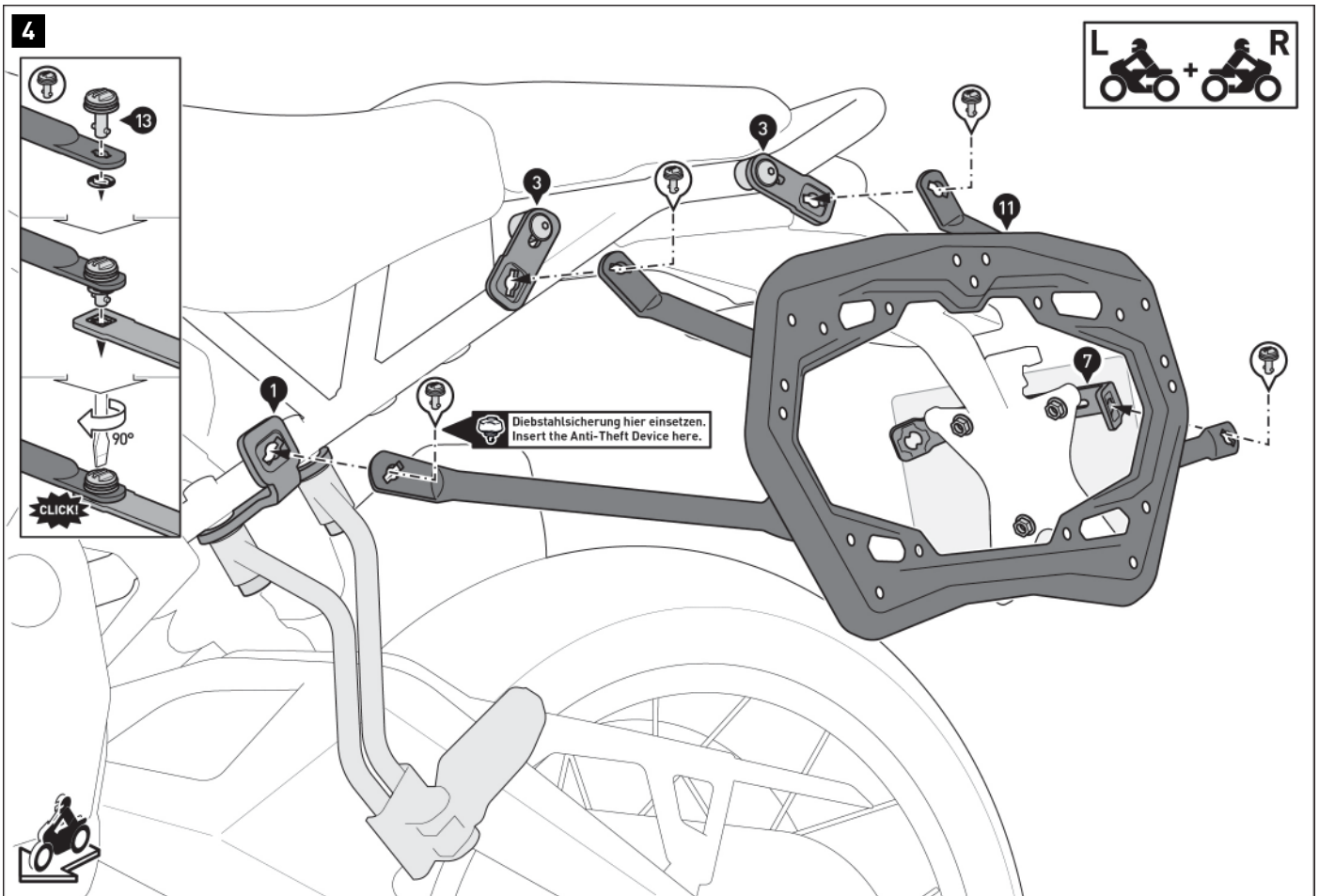

Collegare i telai laterali (11) e (12) con le chiusure rapide (13) sulle staffe di montaggio (1) e (3) e sul connettore a croce (7).
Fissare le chiusure rapide con le rondelle di sicurezza.

Quando tutti i componenti sono posizionati senza tensione, serrare le viti come indicato.

⚠ AVVERTENZA: antifurto disponibile separatamente.

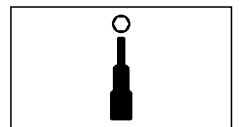

AVVERTENZE SPECIFICHE DEL PRODOTTO

▲ PERICOLO: il carico massimo specificato comprende il peso del bagaglio e del kit adattatore! Si applica il carico massimo del veicolo specificato dal costruttore del veicolo!

 ≤ 12,5 KG (≤ 27,5 lbs) |  ≤ 130 km/h (≤ 80 mph)

▲ AVVERTENZA: i telai laterali sono stati progettati esclusivamente per l'uso con i kit adattatori SW-MOTECH.

▲ AVVERTENZA: smontare i telai laterali quando si viaggia senza bagagli. Utilizzare sempre i telai laterali in coppia.

▲ AVVERTENZA: assicurarsi che le borse laterali **NON** siano investite dal flusso dei gas di scarico una volta montate sul veicolo! Rischio di ustioni!

▲ AVVISO: le modifiche invalidano la garanzia.

▲ AVVISO: osservare le normative specifiche del paese per l'immatricolazione e l'utilizzo del veicolo, nonché le norme TÜV applicabili. Dopo l'assemblaggio, far inserire le parti soggette a omologazione nei documenti del veicolo dal proprio centro di test.

Art.-Nr. / Item No.: **KFT.00.152.35200**

Revision: **01** · Datum / Date: **10 - 2018**

**Adapterkit für PRO Seitenträger –
AERO ABS**

**Adapter kit for PRO side carrier –
AERO ABS**

DEUTSCH - Vielen Dank, dass Sie sich für dieses Premium-Produkt von SW-MOTECH entschieden haben. Bitte besuchen Sie unseren Webshop für weitere Informationen wie Modellzuweisungen und PDF-Anbauanleitung. Erforderliche Dokumente (z. B. ABE) stehen als Download zur Verfügung.

Die Montage und/oder Wartung dieses Produkts erfordert ein gutes technisches Verständnis! Zu Ihrer eigenen Sicherheit empfiehlt SW-MOTECH, die Montage und/oder Wartung durch eine Fachwerkstatt durchführen zu lassen! SW-MOTECH übernimmt keine Haftung für Schäden, die durch eine unsachgemäße Montage und/oder Wartung verursacht wurden!

Beachten Sie alle in der Anbauanleitung angegebenen Hinweise und die für die Montage relevanten Informationen im Fahrzeughandbuch. Nichtbeachtung kann zu Schäden am Fahrzeug bzw. zur Gefährdung des Fahrers führen! Diese Anbauanleitung ist nach unserem derzeitigen Kenntnisstand verfasst worden. Rechtliche Ansprüche auf Richtigkeit bestehen nicht.

Dieses Produkt wurde für Fahrzeuge im Werkzustand entwickelt. Die Kompatibilität mit Original-Zubehörteilen bzw. den Zubehörteilen anderer Hersteller kann nicht gewährleistet werden. Stellen Sie des Weiteren VOR Montage dieses Produkts sicher, dass sich alle beweglichen Teile (z. B. die Kette) im ursprünglichen Wartungszustand befinden. Montiertes Zubehör kann das Fahrverhalten und/oder die Stabilität Ihres Fahrzeugs verändern.

ALLGEMEINE HINWEISE

Beachten Sie die landesspezifischen Vorschriften für Zulassung/Betrieb Ihres Fahrzeugs bzw. anwendbare TÜV-Vorschriften. Lassen Sie eintragungspflichtige Teile nach Montage durch Ihre Prüfstelle in die Fahrzeugpapiere eintragen.

VORBEREITUNG: Lesen Sie die Anbauanleitung aufmerksam und stellen Sie sicher, dass alle Teile der Stückliste vorhanden sind. Achten Sie darauf, dass Ihr Fahrzeug sicher steht und nicht umfallen kann. Schalten Sie den Motor ab und ziehen Sie den Zündschlüssel. Lassen Sie ggf. den Motor/Auspuff abkühlen. Klemmen Sie bei Arbeiten an der Elektrik die Fahrzeugbatterie ab. Verwenden Sie geeignetes Werkzeug. Lassen Sie sich von einer zweiten Person helfen.

MONTAGE: Alle vom Motorrad gelösten Teile und Verbindungen sind gemäß den Fahrzeugherstellereangaben wieder zu montieren oder durch die von SW-MOTECH gelieferten Teile zu ersetzen. Sichern Sie, falls nicht anderweitig definiert, alle Gewinde mit mittelfester, flüssiger Schraubensicherung.

Alle nicht durch SW-MOTECH definierten Anzugsmoment-Vorgaben müssen beim Fahrzeughersteller oder einer Fachwerkstatt erfragt werden!

FUNKTIONSKONTROLLE: Stellen Sie nach der Montage sicher, dass alle zuvor gelösten Teile und Verbindungen wieder ordnungsgemäß montiert wurden. Achten Sie außerdem auf die uneingeschränkte Freigängigkeit und einwandfreie Funktion sämtlicher Fahrzeugteile. Kabel, Züge und Schläuche dürfen nicht scheuern und/oder geklemmt werden. Führen Sie vor Fahrtbeginn eine umfassende Funktionskontrolle durch. Überprüfen Sie nach den ersten 50 km und anschließend in regelmäßigen Abständen das Anzugsmoment aller Schraubverbindungen und den ordnungsgemäßen Sitz des Produkts.

ENGLISH - Thank you for choosing this premium product from SW-MOTECH. Please visit our webshop for additional information, such as application charts and PDF mounting instructions. Any other documents that may be required (e.g. ABE certifications), are also available for download at our webshop.

Installation and/or maintenance of this product require good technical understanding! For your own safety SW-MOTECH recommends having installation and/or servicing carried out by a specialist workshop! SW-MOTECH assumes no liability for damage caused by improper installation and/or maintenance work!

Carefully follow all the directions given in the mounting instructions and pay attention to all relevant information in the vehicle manual during assembly. Nonconformance can lead to vehicle damage or even endanger the driver! These mounting instructions are written based on our current state of knowledge. Legal requirements for accuracy do not exist.

This product was developed for vehicles in their factory setting. Compatibility with original accessory parts or other manufacturers' accessory parts is not guaranteed. Furthermore, BEFORE installing this product, make sure that all moving parts (e.g. the chain) are in the original state of maintenance. Installed accessories can change the driving behaviour and/or stability of your vehicle.

GENERAL INFORMATION

Observe the country-specific regulations concerning vehicle registration/operation as well as TÜV regulations if applicable. If required, register installed parts in the vehicle documents through an appropriate inspection authority.

PREPARATION: Read the mounting instructions carefully and make sure that all items of the parts list are included. Make sure that your vehicle is parked safely and cannot fall over. Turn off the engine and remove the ignition key. Let the motor/exhaust cool off if necessary. Disconnect the vehicle battery when working on the electrical system. Use appropriate tools. Have another person to help you.

MOUNTING: All parts and connections removed from the vehicle must be reinstalled in accordance with the vehicle manufacturers' specifications or replaced by parts delivered by SW-MOTECH. Secure all threads, unless otherwise specified, with medium-strength liquid thread locker.

Torque specifications undefined by SW-MOTECH must be obtained from the vehicle manufacturer or by a specialist workshop!

FUNCTION CHECK: After installation make sure that all parts and connections previously removed are properly replaced. Also make sure that no moving parts are obstructed and no function of the vehicle is hindered in any way. Cables and hoses must not rub and/or be pinched. Before starting to ride, perform a comprehensive check of all functions. After the first 50 km and then at regular intervals, check the tightening torque of all screw connections and the proper fit of the product.

Konfektionierung durch / Packed by:

Datum der Konfektionierung / Date of packaging:



SW-MOTECH GmbH & Co. KG

Ernteweg 8/10
35282 Rauschenberg
Germany

Tel. / phone + 49 (0)6425 / 8168 - 050
Fax / fax + 49 (0)6425 / 8168 - 10

info@sw-motech.com
www.sw-motech.com

STÜCKLISTE / PARTS LIST

Schritt Step	Nr. No.	Art.-Nr. / Bezeichnung * Item No. / Description *	Artikel	Part	Anzahl ** Quantity **	N-m ***
(1)	BC.HTA.00.675.013		Verschlussbolzen	Lock Bolt	2 / 2	
(2)	M6 x 20; DIN 6912		Innensechskantschraube, fl. Kopf	Hexagon Socket Screw, short head	2 / 2	9
(3)	KFT.00.152.071		Führungsbolzen	Guide Bolt	6 / 6	
(4)	M6 x 20; DIN 7991		Senkkopfschraube	Countersunk Screw	6 / 6	9
(5)	M6; DIN 6927		Mutter mit Bund, selbstsichernd; schwarz	Lock Nut with Flange; black	8 / 8	

8.8	Regelgewinde / Coarse Thread Ø	M4	M5	M6	M8	M10	M12	10.9	Regelgewinde / Coarse Thread Ø	M4	M5	M6	M8	M10	M12	
	Stahl FK 8.8 / Steel CL 8.8	N-m	2,8	5,5	9,6	23	46	79	Stahl FK 10.9 / Steel CL 10.9	N-m	4,1	8,1	14	34	67	115

* Alle Maßangaben in Millimeter. - ** Der zweite Wert gibt die Gesamtanzahl des jew. Artikels in der Lieferung an.
 *** **Keine Anzugsmomentvorgabe: Verwenden Sie das vom Fzg.-Hersteller definierte Anzugsmoment!** Das Standard-Anzugsmoment der Tabelle kann verwendet werden, wenn es den Fzg.-Hersteller-Vorgaben entspricht.

* All measurements in millimeters. - ** The second number indicates the total quantity of the part in the delivery.
 *** **No torque specifications: Use the torque defined by vehicle manufacturer!** The standard torque in this table can be used as long as it is within the vehicle manufacturer's specifications.



MONTAGE / MOUNTING

PRO Seitenträger
PRO side carrier



HINWEIS: Die Zeichnung zeigt die Montage am **rechten** PRO-Seitenträger. Montieren Sie die Teile am linken PRO-Seitenträger auf die gleiche Weise wie am rechten PRO-Seitenträger.

Verschrauben Sie die gezeigten Teile an ihren PRO-Seitenträgern (separat erhältlich). Ziehen Sie die Schrauben wie in der Stückliste vorgegeben an.

NOTE: The illustration shows the mounting to the **right** PRO side carrier. Mount the parts to the left PRO side carrier in the same way as to the right PRO side carrier.

Attach the shown parts to your PRO side carriers (sold separately). Tighten the screws as specified in the parts list.

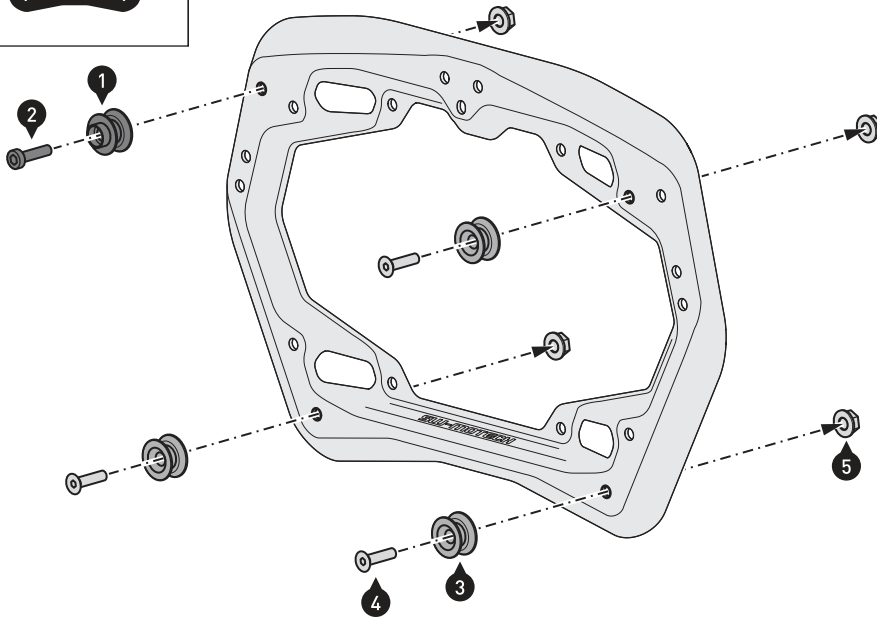

Art.-Nr. / Item No.: **BC.HTA.00.675.12000/B**

Revision: **02** · Datum / Date: **08 - 2020**

AERO ABS Seitenkoffer-Set

AERO ABS side case set

DEUTSCH - Vielen Dank, dass Sie sich für dieses Premium-Produkt von SW-MOTECH entschieden haben. Bitte besuchen Sie unseren Webshop für weitere Informationen wie Modellzuweisungen und PDF-Anbauanleitung. Erforderliche Dokumente (z. B. ABE) stehen als Download zur Verfügung.

Die Montage und/oder Wartung dieses Produkts erfordert ein gutes technisches Verständnis! Zu Ihrer eigenen Sicherheit empfiehlt SW-MOTECH, die Montage und/oder Wartung durch eine Fachwerkstatt durchführen zu lassen! SW-MOTECH übernimmt keine Haftung für Schäden, die durch eine unsachgemäße Montage und/oder Wartung verursacht wurden! Beachten Sie alle in der Anbauanleitung angegebenen Hinweise und die für die Montage relevanten Informationen im Fahrzeughandbuch. Nichtbeachtung kann zu Schäden am Fahrzeug bzw. zur Gefährdung des Fahrers führen! Diese Anbauanleitung ist nach unserem derzeitigen Kenntnisstand verfasst worden. Rechtliche Ansprüche auf Richtigkeit bestehen nicht.

Dieses Produkt wurde für Fahrzeuge im Werkzustand entwickelt. Die Kompatibilität mit Original-Zubehörteilen bzw. den Zubehörteilen anderer Hersteller kann nicht gewährleistet werden. Stellen Sie des Weiteren VOR Montage dieses Produkts sicher, dass sich alle beweglichen Teile (z. B. die Kette) im ursprünglichen Wartungszustand befinden. Montiertes Zubehör kann das Fahrverhalten und/oder die Stabilität Ihres Fahrzeugs verändern.

ALLGEMEINE HINWEISE

Beachten Sie die landesspezifischen Vorschriften für Zulassung / Betrieb Ihres Fahrzeugs bzw. anwendbare TÜV-Vorschriften. Lassen Sie eintragungspflichtige Teile nach Montage durch Ihre Prüfstelle in die Fahrzeugpapiere eintragen.

VORBEREITUNG: Lesen Sie die Anbauanleitung aufmerksam und stellen Sie sicher, dass alle Teile der Stückliste vorhanden sind. Achten Sie darauf, dass Ihr Fahrzeug sicher steht und nicht umfallen kann. Schalten Sie den Motor ab und ziehen Sie den Zündschlüssel. Lassen Sie ggf. den Motor / Auspuff abkühlen. Klemmen Sie bei Arbeiten an der Elektrik die Fahrzeugbatterie ab. Verwenden Sie geeignetes Werkzeug. Lassen Sie sich von einer zweiten Person helfen.

FUNKTIONSKONTROLLE: Da es sich um ein universelles Produkt handelt, stellen Sie unbedingt VOR der ersten Nutzung sicher, dass sich das Produkt ohne Probleme und sachgerecht an Ihrem Fahrzeugtyp befestigen und verwenden lässt. Achten Sie nach der Befestigung auf die uneingeschränkte Freigängigkeit und einwandfreie Funktion sämtlicher Fahrzeugteile. Leuchtmittel wie Rücklicht und Blinker dürfen nicht in ihrer Funktion eingeschränkt werden. Kabel, Züge und Schläuche dürfen nicht scheuern und/oder geklemmt werden. Führen Sie vor Fahrtbeginn eine umfassende Funktionskontrolle durch.

PRODUKTSPEZIFISCHE HINWEISE

ACHTUNG: Das Fahr-/Bremsverhalten des Motorrads verändert sich nach Befestigung dieses Produkts merklich!

ACHTUNG: Je nach Ort der Befestigung kann die Kurven- und Bodenfreiheit durch dieses Produkt eingeschränkt werden!

ACHTUNG: Überprüfen Sie vor Fahrtbeginn und bei jeder Rast (alle 200 km) den ordnungsgemäßen Sitz des Produkts!

Maximale Zuladung	Höchstgeschwindigkeit
 10 KG (22 lbs) pro Koffer	 130 km/h (80 mph)

ACHTUNG: Die Zuladung des verwendeten SW-MOTECH Seitenträgers darf nicht überschritten werden (siehe Anbauanleitung des Seitenträgers)! Es gilt die vom Fahrzeughersteller genannte maximale Zuladung des Fahrzeugs!

ACHTUNG 

NICHT FÜR DEN OFFROAD-EINSATZ GEEIGNET!

ENGLISH - Thank you for choosing this premium product from SW-MOTECH. Please visit our webshop for additional information, such as application charts and PDF mounting instructions. Any other documents that may be required (e.g. ABE certifications), are also available for download at our webshop.

Installation and/or maintenance of this product require good technical understanding! For your own safety SW-MOTECH recommends having installation and/or servicing carried out by a specialist workshop! SW-MOTECH assumes no liability for damage caused by improper installation and/or maintenance work! Carefully follow all the directions given in the mounting instructions and pay attention to all relevant information in the vehicle manual during assembly. Nonconformance can lead to vehicle damage or even endanger the driver! These mounting instructions are written based on our current state of knowledge. Legal requirements for accuracy do not exist.

This product was developed for vehicles in their factory setting. Compatibility with original accessory parts or other manufacturers' accessory parts is not guaranteed. Furthermore, BEFORE installing this product, make sure that all moving parts (e.g. the chain) are in the original state of maintenance. Installed accessories can change the driving behaviour and/or stability of your vehicle.

GENERAL INFORMATION

Observe the country-specific regulations concerning vehicle registration / operation as well as TÜV regulations if applicable. If required, register installed parts in the vehicle documents through an appropriate inspection authority.

PREPARATION: Read the mounting instructions carefully and make sure that all items of the parts list are included. Make sure that your vehicle is parked safely and cannot fall over. Turn off the engine and remove the ignition key. Let the motor / exhaust cool off if necessary. Disconnect the vehicle battery when working on the electrical system. Use appropriate tools. Have another person to help you.

FUNCTION CHECK: This is a universal product. For this reason make sure BEFORE the first use, that the product can be fixed properly and used without problems with your vehicle type. After fixation also make sure that no moving parts are obstructed and the function of the vehicle is not hindered in any way. Lamps as taillight and turn signals must not be limited in their function. Cables and hoses must not rub and/or be pinched. Before starting to ride, perform a comprehensive check of all functions.

PRODUCT SPECIFIC INFORMATION

ATTENTION: Riding with this product may affect the motorcycles driving and braking performance!

ATTENTION: Depending on the location of fixation, cornering and ground clearance can be reduced by using this product!

ATTENTION: Before riding and at each stop (every 200 km) check proper fixation of the product!

Maximum Load	Maximum Speed
 10 KG (22 lbs) per case	 130 km/h (80 mph)

ATTENTION: The maximum load of the used SW-MOTECH side carrier must not be exceeded (refer mounting instructions of the side carrier)! The maximum vehicle load specified by the manufacturer must not be exceeded!

ATTENTION 

NOT FOR OFFROAD-USE!

Konfektionierung durch / Packed by:

Datum der Konfektionierung / Date of packaging:



SW-MOTECH GmbH & Co. KG
Ernteweg 8/10
35282 Rauschenberg
Germany

Tel. / phone + 49 (0)6425 / 8168 - 050
Fax / fax + 49 (0)6425 / 8168 - 10
info@sw-motech.com
www.sw-motech.com

STÜCKLISTE / PARTS LIST

Schritt Step	Nr. No.	Art.-Nr. / Bezeichnung * Item No. / Description *	Artikel	Part	Anzahl ** Quantity **	N-m ***
1	(1)	BC.HTA.00.675.901 / 902.01	AERO ABS Seitenkoffer; links / rechts	AERO ABS Side Case; left / right	2 / 2	
4	(2)	BC.LOC.00.001.10200/B	Motorradtaschen-Schloss	Lock for Motorcycle Luggage	2 / 2	
	(3)	BC.ZUB.00.104.30000	Wasserdichte Innentasche	Waterproof Inner Bag	2 / 2	

8.8	Regelgewinde / Coarse Thread Ø	M4	M5	M6	M8	M10	M12
	Stahl FK 8.8 / Steel CL 8.8	N-m	2,8	5,5	9,6	23	46

10.9	Regelgewinde / Coarse Thread Ø	M4	M5	M6	M8	M10	M12
	Stahl FK 10.9 / Steel CL 10.9	N-m	4,1	8,1	14	34	67

* Alle Maßangaben in Millimeter. - ** Der zweite Wert gibt die Gesamtanzahl des jew. Artikels in der Lieferung an.
 *** **Keine Anzugsmomentvorgabe: Verwenden Sie das vom Fzg.-Hersteller definierte Anzugsmoment!** Das Standard-Anzugsmoment der Tabelle kann verwendet werden, wenn es den Fzg.-Hersteller-Vorgaben entspricht.

* All measurements in millimeters. - ** The second number indicates the total quantity of the part in the delivery.
 *** **No torque specifications: Use the torque defined by vehicle manufacturer!** The standard torque in this table can be used as long as it is within the vehicle manufacturer's specifications.

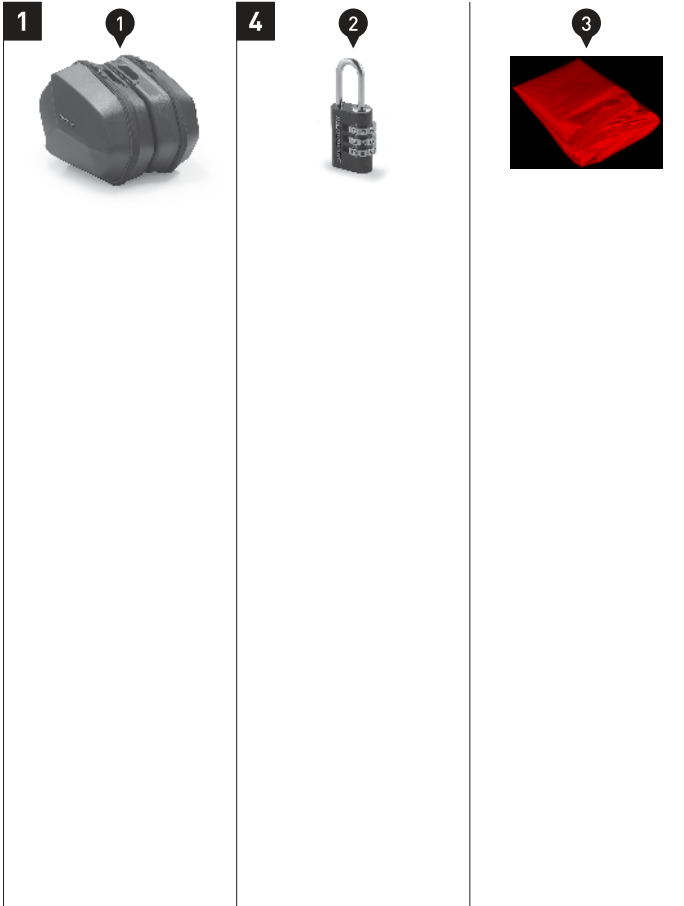

PFLEGE / CARE

Pflege

Verwenden Sie zum Reinigen der Seitenkoffer warme Seifenlauge und ein weiches, sauberes Tuch. Spülen Sie anschließend mit klarem Wasser nach.
Verwenden Sie KEINE scharfen Reinigungsmittel, raue Putzutensilien oder einen Hochdruckreiniger! Reinigen Sie die Seitenkoffer unbedingt nach Winterfahrten, um Schäden durch das Salz zu vermeiden.
 Schwergängige Reißverschlüsse können mit etwas Talkumpulver wieder gängig gemacht werden.
ACHTUNG: Oberflächenmaterialien können bei längerer und intensiver Sonneneinstrahlung und Umwelteinflüssen (z. B. SMOG, saurer Regen, etc.) Farbveränderungen (Ausbleichen) unterliegen! Dafür übernimmt SW-MOTECH keine Haftung.

Care

To clean the side cases, use warm, soapy water and a soft, clean cloth. Rinse with clean water.
Do NOT use strong cleaning agents, rough cleaning tools or high pressure washer! Clean the side cases after riding in salty conditions, to avoid damage from salt.
 Hard to open zippers can be loosened with a small amount of talcum powder.
ATTENTION: Surface materials can experience color changes or fading when exposed to direct sunlight for extended periods of time and by environmental factors (e.g., SMOG, acid rain, etc.)! SW-MOTECH assumes no liability for this.





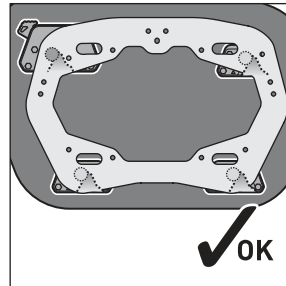
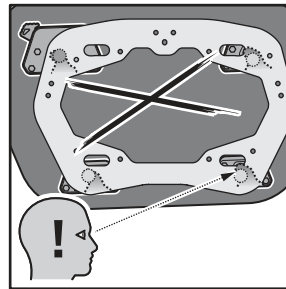
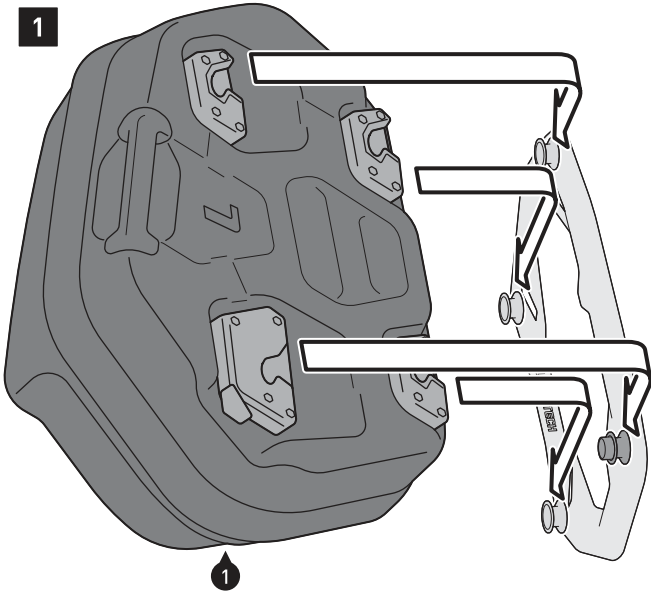

Schritt [1]: Setzen Sie die vier Arretierungsöffnungen des Seitenkoffers (1) auf die Führungsbolzen des montierten SW-MOTECH Seitenträgers.

Schritt [2]: Drücken Sie den Seitenkoffer leicht nach unten, bis dieser fest am Seitenträger sitzt. **ACHTUNG: Achten Sie darauf, dass alle vier Führungsbolzen gleichzeitig einrasten! Achten Sie außerdem auf das deutlich hörbare Einrastgeräusch des Verschlussmechanismus und dass die rote Markierung unter dem Schieber nicht sichtbar ist!**

Drücken Sie zum Entriegeln den Schieber nach unten.

ACHTUNG: Achten Sie darauf, dass keine Komponenten des Seitenkoffers mit heißen und beweglichen Teilen des Fahrzeugs in Kontakt kommen können! Achten Sie des Weiteren darauf, dass alle Komponenten mindestens 5 cm Abstand zu heißen Teilen sowie dem heißen Abgasstrom des Auspuffs haben! Stellen Sie nach der Montage sicher, dass dieser Abstand in jedem Federzustand des Fahrzeugs eingehalten wird!

Schritt [3]: Um den montierten Seitenkoffer (1) gegen Diebstahl zu schützen, muss dieser zunächst geöffnet werden.

Drücken Sie nun den Sicherungsknopf und drehen ihn gemäß der Pfeilmarkierung, bis der Sicherungsknopf einrastet.

Schritt [4]: Verriegeln Sie nun die Puller des geschlossenen Reißverschlusses mit dem beiliegenden Schloss (2). Wir empfehlen, den Sicherungsknopf während der Fahrt immer in der abgeschlossenen Position zu belassen.

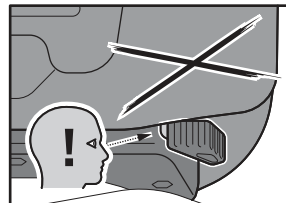
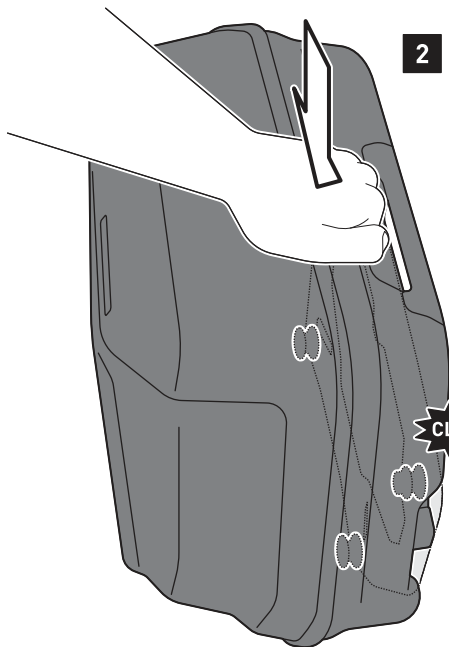

SICHTBARE ROTE MARKIERUNG: NICHT korrekt verriegelt! Verlustgefahr!
VISIBLE RED MARKING: NOT correctly locked! Risk of loss!

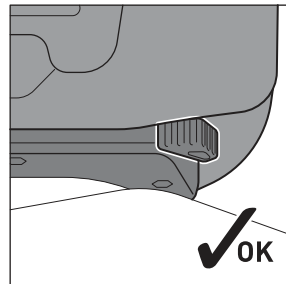

Step [1]: Place the four locking openings of the side case (1) onto the guide bolts of the mounted SW-MOTECH side carrier.

Step [2]: Press the side case slightly downward, until it properly rests on the side carrier.

ATTENTION: Make sure that all four guide bolts engage at the same time! Pay attention to the clearly audible snap sound of the locking mechanism and that the red marking under the slider is not visible!

To release press the slider downward.

ATTENTION: All components of the side case must not contact any hot or moving parts of the vehicle! All parts should also remain 5 cm away from hot parts of the vehicle and remain clear of the exhaust stream! After mounting, make sure there are no clearance issues while the suspension is both compressed and extended.

Step [3]: To protect the mounted side case against theft, open it (1). Then press the locking button and turn it according to the arrow mark until the locking button engages.

Step [4]: Then lock the closed zipper with the included lock (2). We recommend leaving the locking button in the closed position during the ride.

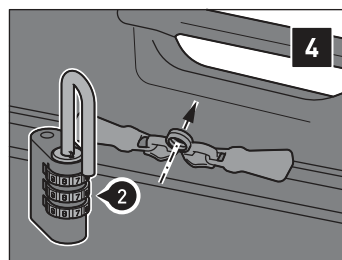
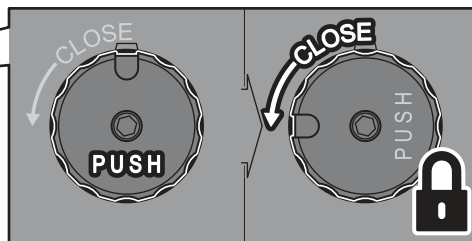
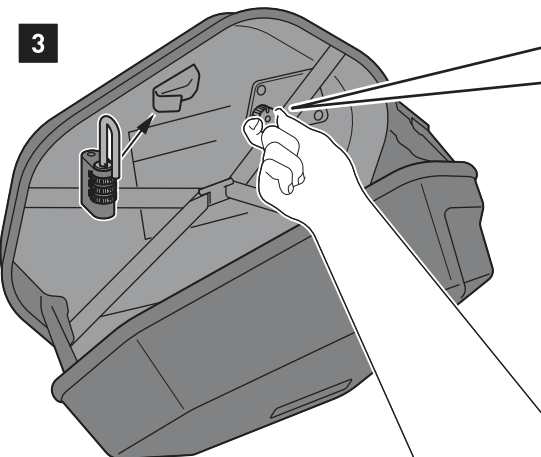

MONTAGE / MOUNTING

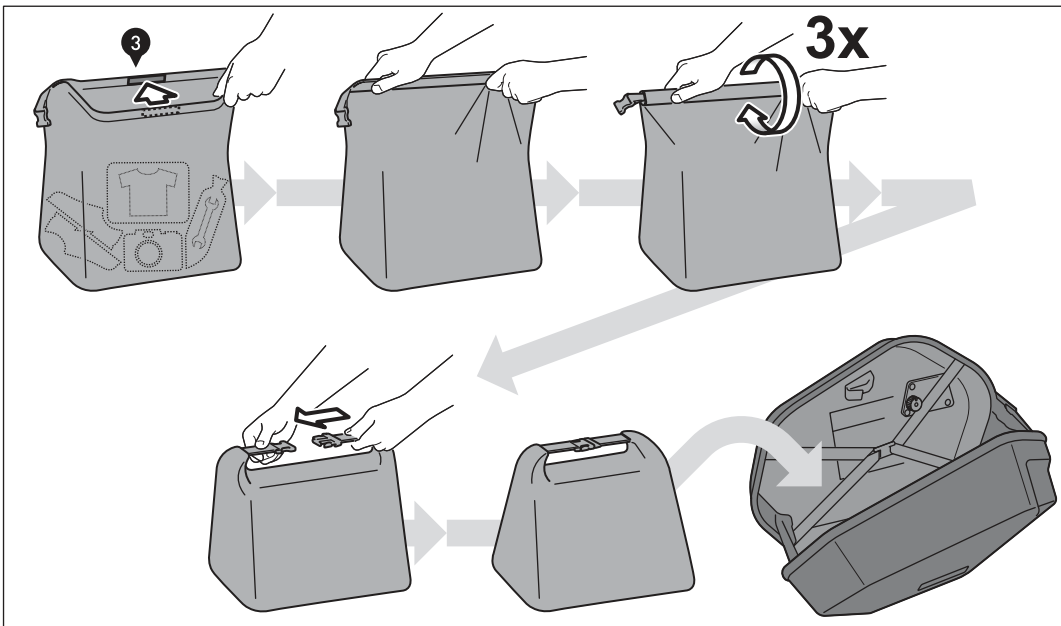

Verwenden Sie die beiliegende wasserdichte Innentasche (3), um Ihr Gepäck vor Feuchtigkeit zu schützen.

Use the included waterproof inner bag (3) to protect your luggage from moisture.

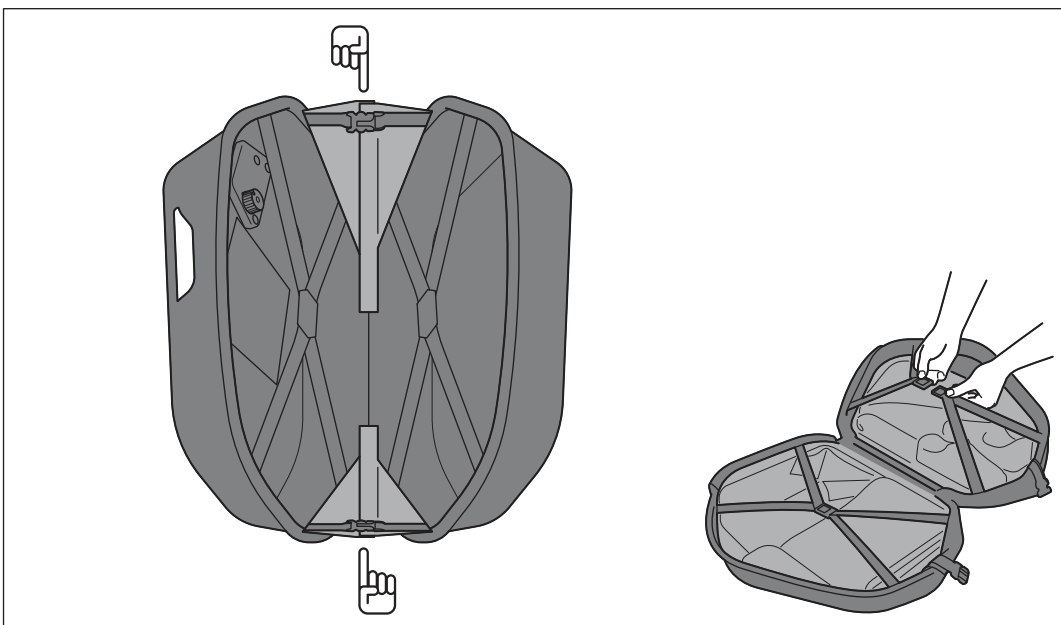

Um den Seitenkoffer (1) einfacher beladen zu können, öffnen Sie die Schnallen und Klettverschlüsse der Öffnungsreduzierungen, wie in der Zeichnung gezeigt.

For an easier loading of the side case (1), open the buckles and hook and loop fasteners of the opening reductions, as shown in the drawing.

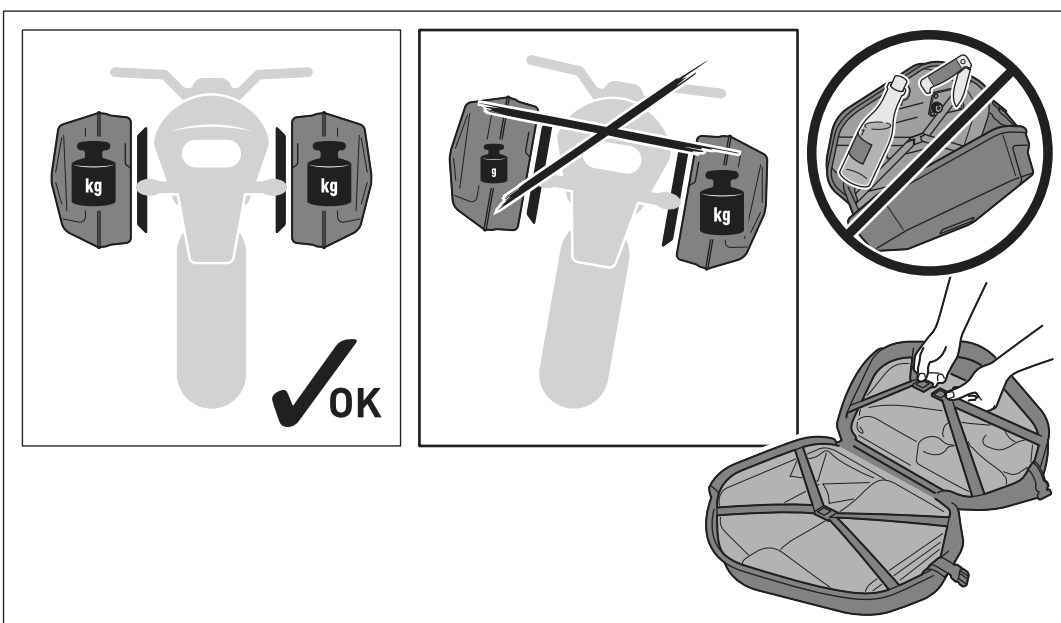

ACHTUNG: Achten Sie bei beidseitiger Verwendung der Seitenkoffer auf die gleichmäßige Verteilung der Ladung! Stellen Sie sicher, dass die Ladung während der Fahrt gegen Verrutschen gesichert ist!

ACHTUNG: Achten Sie darauf, niemals scharfkantige, spitze oder ähnliche Gegenstände zu verstauen, welche Verletzungen an Personen bzw. Beschädigungen am Fahrzeug/Seitenkoffer verursachen könnten!

ATTENTION: Make sure weight is evenly distributed between the left and right side if you want to use both side cases! Make sure that the loading is secured against shifting during the ride!

ATTENTION: Never store pointy or sharp-edged objects, which could cause injury to persons or damage to the vehicle/side case!

ANBAUANLEITUNG / MOUNTING INSTRUCTIONS

Art.-Nr. / Item No.: **QLS.00.095.1000*/B** · Revision: **00** · **01 - 2021**
QLS.00.046.1010*/B

Diebstahlsicherung für PRO / EVO Seitenträger Anti-theft protection for PRO / EVO side carrier

ACHTUNG / ATTENTION

NIEMALS die Schließzylinder mit **ÖL** schmieren! Verwenden Sie nur **Graphitpulver!** **NEVER** lubricate lock cylinders with oil! Use **graphite powder** only!

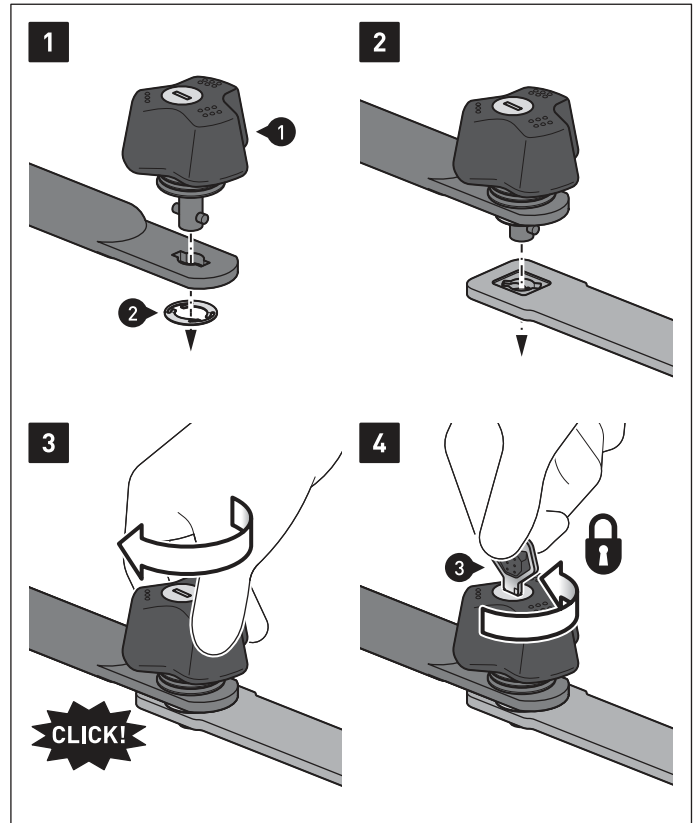

Nr. No.	Art.-Nr. / Bezeichnung Item No. / Description	Anzahl Quantity
	QLS.00.095.1000* (PRO)	
(1)	QLS.00.095.520	2 / 2
(2)	SV.ST.095.007.LK.02	2 / 2
(3)	ALK.00.165.A63	2 / 2
	QLS.00.046.1010* (EVO)	
(1)	QLS.00.046.520	2 / 2
(2)	CAM.2312S10-1BP	2 / 2
(3)	ALK.00.165.A63	2 / 2



Irrtümer und Änderungen vorbehalten. Technische und Design-Änderungen vorbehalten.
 Errors and omissions excepted, Technical and design modifications are subject to change.

Copyright by
 SW-MOTECH GmbH & Co. KG

ANBAUANLEITUNG / MOUNTING INSTRUCTIONS

Art.-Nr. / Item No.: **QLS.00.095.1000*/B** · Revision: **00** · **01 - 2021**
QLS.00.046.1010*/B

Diebstahlsicherung für PRO / EVO Seitenträger Anti-theft protection for PRO / EVO side carrier

ACHTUNG / ATTENTION

NIEMALS die Schließzylinder mit **ÖL** schmieren! Verwenden Sie nur **Graphitpulver!** **NEVER** lubricate lock cylinders with oil! Use **graphite powder** only!

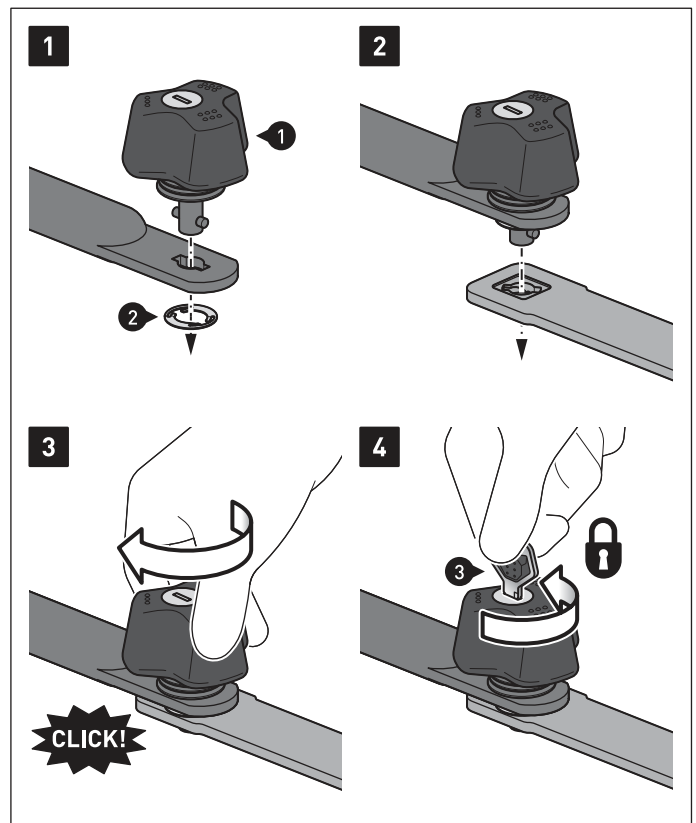

Nr. No.	Art.-Nr. / Bezeichnung Item No. / Description	Anzahl Quantity
	QLS.00.095.1000* (PRO)	
(1)	QLS.00.095.520	2 / 2
(2)	SV.ST.095.007.LK.02	2 / 2
(3)	ALK.00.165.A63	2 / 2
	QLS.00.046.1010* (EVO)	
(1)	QLS.00.046.520	2 / 2
(2)	CAM.2312S10-1BP	2 / 2
(3)	ALK.00.165.A63	2 / 2



Irrtümer und Änderungen vorbehalten. Technische und Design-Änderungen vorbehalten.
 Errors and omissions excepted, Technical and design modifications are subject to change.

Copyright by
 SW-MOTECH GmbH & Co. KG