

FITTING INSTRUCTIONS

Installation for RIGHT Side.

Repeat for *LEFT* side with applicable parts.







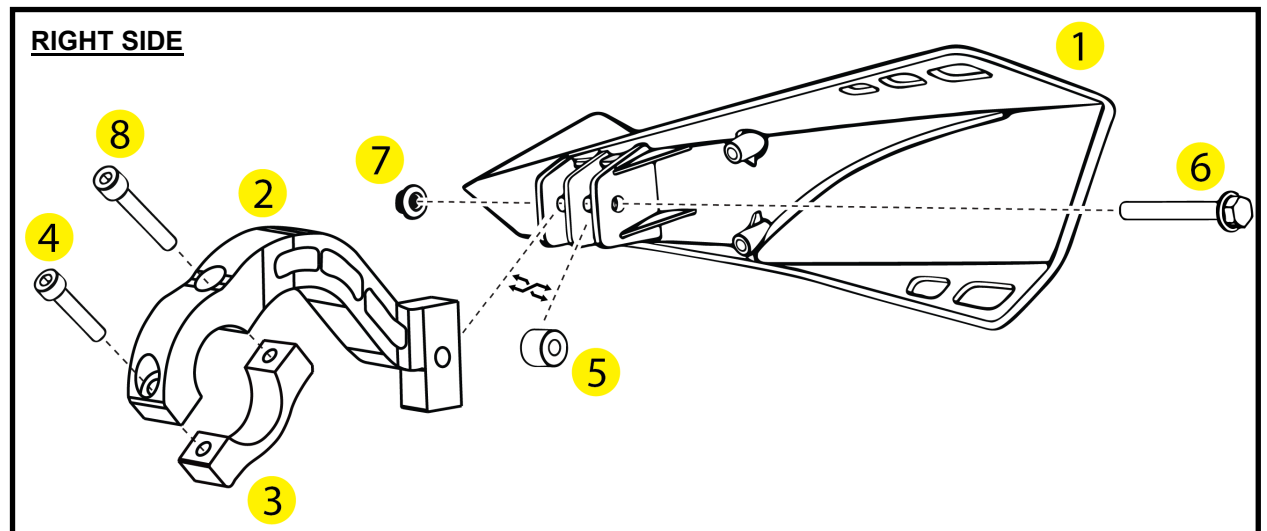

1. Assemble handguard as per **Diagram**.
2. Attach clamp frame (2) and clamp saddle (3) to the handlebar in preferred position with bolts (4) and (8).

Note: Clamp frame has an offset design and can be positioned on either side of the brake controls. Preferred, is to the inside of the brake control with offset toward the outside.

3. Attach handguard to the clamp frame in either of the two mounting positions. Fit spacer (5) in alternate position.
4. Hold nut (7) in place as you install bolt (6).

Caution: **DO NOT** overtighten bolts.



<p>1 MTB Guard</p>  <p>PN: SAB19-LR Pcs. Left / Right Pair</p>	<p>2 Clamp Frame</p>  <p>PN: CF20-14-LR Pcs. Left / Right Pair</p>	<p>3 Clamp Saddle</p>  <p>PN: CS20-12 Pcs. 2</p>	<p>4 Socket Head Bolt 20mm</p>  <p>PN: M5X20SHCSZP Pcs. 2</p>	<p>5 Spacer</p>  <p>PN: SP10-12-5 Pcs. 2</p>	<p>6 Hex Head Bolt 35mm</p>  <p>PN: M5X35HHFZP Pcs. 2</p>	<p>7 Nylock Nut Flange</p>  <p>PN: M5FLN Pcs. Set of 2</p>	<p>8 Socket Head Bolt 25mm</p>  <p>PN: M5X25SHCSZP Pcs. 2</p>
--	--	--	--	--	---	--	---

Recommended Torque Settings	
M5	5 Nm (3.7 lbf ft)

CAUTION:

Installation of the handguard is safety-relevant work and can be complicated. We recommend the installation be performed by a bicycle service technician. Rideworx accepts no liability for damage caused by improper mounting. All screws, bolts and nuts, including all replacement hardware provided by Rideworx, should be tightened to the torque specified in the table. After the first 10km of riding check all screws, bolts and nuts are tightened to the correct torque. We recommend a medium strength liquid thread lock product on bolts (4) and (8).

WARNING:

Check operation of all handlebar controls to ensure they are operating correctly and are in accordance with the OEM specifications. Do not ride the bicycle if any controls are not operating correctly. Check periodically that all bolts are tight.



Email: info@barkbusters.net
Web: www.barkbusters.net



Disclaimer:

A failure to follow these fitting instructions could cause serious injury, death or property damage. These handguards are intended solely for use with bicycles that have not been modified. They are not designed to prevent injury or death while riding or in an accident or crash. The user must ensure that all controls are free of the handguards every time that they ride. By installing and/or using this product you acknowledge that you accept these terms and have followed the fitting instructions.