

Preparation: HONDA Handlebar Weight Removal

Remove original handlebar end weight with internal weight parts.

Left side, roll back hand grip and depress the two retaining clips through the holes in the handlebar with a screwdriver. There is one top and one bottom. To access holes on right side, unscrew throttle housing and separate the two halves enough to slide the twist grip in from the end. Leave handlebar weight connected to the internal weight to help with removing the internal parts. Pull on weight while pressing clips through hole. See pictures to right.

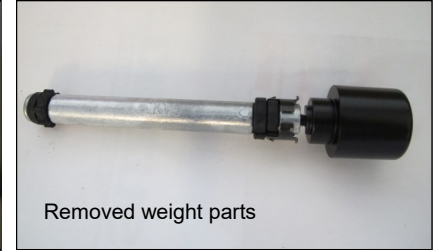

Fitting Procedure:

Loosely assemble clamp to handlebar as per diagrams. Attach aluminium bar (1) with applicable parts to the handlebar and also to the clamp connector (7).







Notes: Preferred aluminium bar position is horizontal when viewed from side.
On the left side use 15mm spacer (14) instead of 17mm spacer (10)

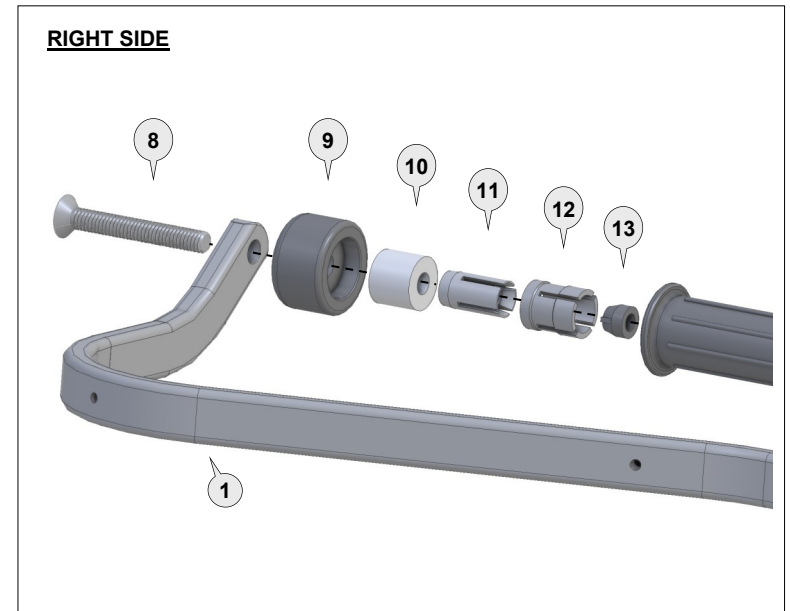
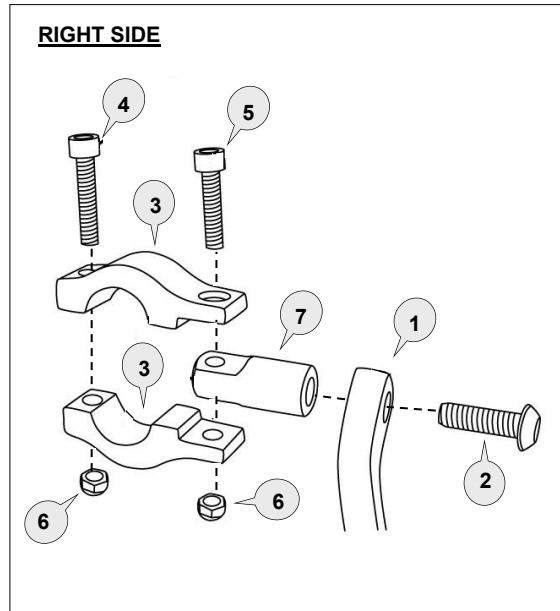



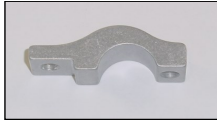
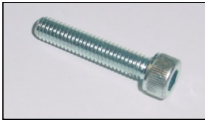

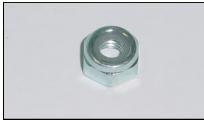
Tighten bolts in the following order:

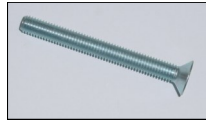
- **Tighten (8).**
- **Tighten bolt (2)** through the aluminium bar (1) to the clamp connector (7) of the clamp assembly.
- **Tighten bolt (5)** to solidly lock the clamp connector (7) between the clamp saddles (3).
- **Tighten bolt (4)** to secure the clamp assembly firmly to the handlebar.

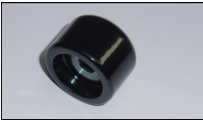
Note: The clamp is designed to allow the nut on bolt (5) to pull into the recessed hole. This eliminates the need for a wrench after the bolt starts to tighten.



| | | | | | | | |
|--|---|--|--|---|---|---|--|
| 1 Aluminium Bar  PN: BAR-V-040 Pcs. 1 Left & 1 Right | 2 Button Head Bolt 25mm  PN: M8X25BHCSZP Pcs. 2 | 3 Clamp Saddle  PN: CS-STD Pcs. 4 pieces | 4 Socket Head Bolt 30mm  PN: M6X30SHCSZP Pcs. 2 | 5 Socket Head Bolt 25mm  PN: M6X25SHCSZP Pcs. 2 | 6 Nylock Nut 6mm  PN: M6LN Pcs. 4 | 7 Clamp Connector  PN: CP4 Pcs. 2 | 8 Flat Head Bolt 75mm  PN: M8X75FHCSZP-FT Pcs. 2 |
|--|---|--|--|---|---|---|--|

| | | | | | |
|--|---|--|--|--|--|
| 9 Bar End Weight  PN: BEW35 Pcs. 2 | 10 Spacer (17mm) RIGHT  PN: SP17-20-8 Pcs. 1 | 11 Bar End Expander  PN: BBE14A Pcs. 2 | 12 Collet  PN: COLLET14-18 Pcs. 2 | 13 Taper Nut  PN: NUT12 Pcs. 2 | 14 Spacer (15mm) LEFT  PN: BSSRT15 Pcs. 1 |
|--|---|--|--|--|--|

Personalise Your Protection
Guard options sold separately

JET JET-003
VPS VPS-003
Storm STM-003
CARBON BCF-003

See below for correct bar orientation

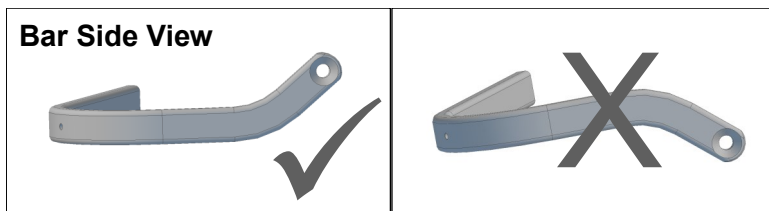

| Recommended Torque Settings | |
|-----------------------------|---------------------|
| M6 | 10 Nm (7.4 lbf ft) |
| M8 | 20 Nm (14.8 lbf ft) |

CAUTION:

Installation of the handguard is safety-relevant work and can be complicated. We recommend the installation be performed by a motorcycle service technician. Rideworx accepts no liability for damages caused by improper mounting. All screws, bolts and nuts, including all replacement hardware provided by Rideworx, should be tightened to the torque specified in the table. After the first 50km of riding check all screws, bolts and nuts are tightened to the correct torque. We recommend a medium strength liquid thread lock product on all fasteners.

WARNING:

Check operation of all handlebar controls, specifically the throttle, front brake, kill switch and clutch to ensure they are operating correctly and are in accordance with the OEM specifications. Do not ride the motorcycle if any controls are not operating correctly. Check periodically that all bolts are tight.

Disclaimer:

A failure to follow these fitting instructions could cause serious injury, death or property damage. These handguards are intended solely for use with motorcycles/ATV/snowmobiles/scooters that have not been modified. They are not designed to prevent injury or death while riding or in an accident or crash. The user must ensure that all controls are free of the handguards every time that they ride. By installing and/or using this product you acknowledge that you accept these terms and have followed the fitting instructions.



Phone: +61 (0)2 4271 8244
Email: info@barkbusters.net
Web: www.barkbusters.net



Barkbusters
www.barkbusters.net

Esempio di aggancio
delle plastiche VPS

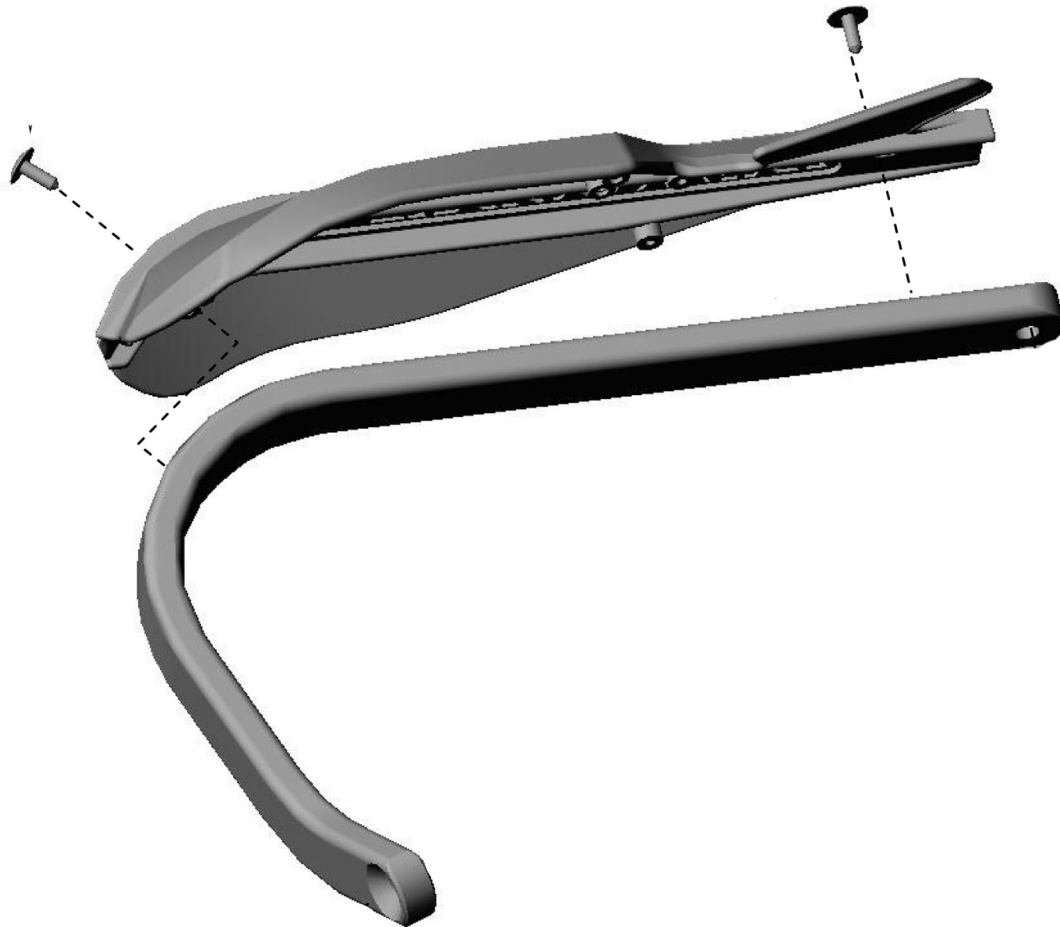

Phone: +61 (0)2 4271 8244
Email: info@barkbusters.net