

FITTING INSTRUCTIONS for...

- BMW F650GS - twin cylinder ('08-'12)
- BMW F800GS ('08-'12)
- BMW R1200GS (up to '12)
- BMW R1200GS Adventure (up to '13)
- BMW HP2 Megamoto ('07-'09)
- TRIUMPH Tiger 1050 Sport ('13 on)

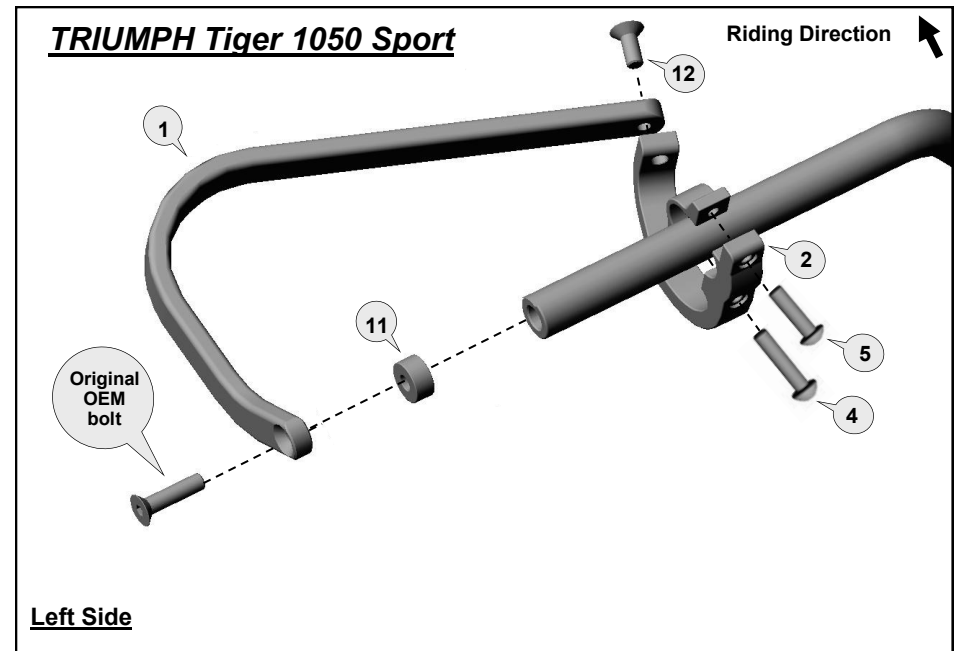
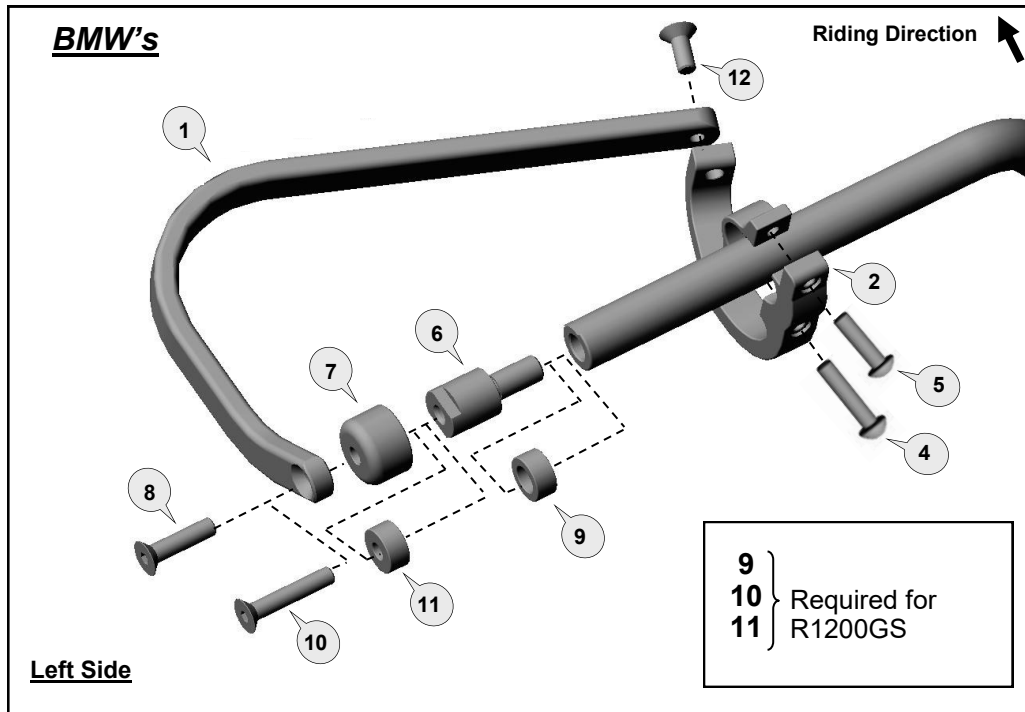

Fitting Procedure shown for the LEFT side (repeat for right side with applicable parts)

Loosely assemble clamp to the handlebar with applicable parts (see diagram for your model motorbike). Attach the handguard backbone with applicable parts to the handlebar end and also to the clamp.

Note: The preferred backbone position is horizontal when viewed from the side.
Tighten all bolts in the following order (8) or (10) or (Original OEM bolt on Tiger), then (12), then (4 and 5).
Use recommended torque specifications over page.

Fitting Tips:

It may be necessary to move the brake and clutch controls toward the handlebar end by a few millimetres to achieve a correct fit. If the clamp frame (2 & 3) makes contact with the tank at full steering lock, it may be necessary to rotate the handlebar up (forward) slightly to allow adequate clearance.

Bar Side View

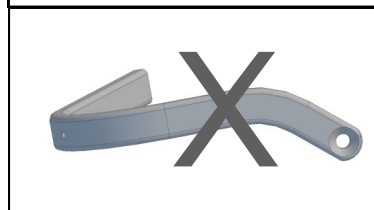
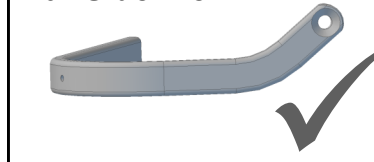













Personalise Your Protection

Guard options sold separately

JET	JET-003
VPS	VPS-003
Storm	STM-003
CARBON	BCF-003



Phone: +61 (0)2 4271 8244
Email: info@barkbusters.net

<p>1 Aluminium Bar</p>  <p>PN: BAR-V-036 Pcs. 2 (L & R)</p>	<p>2 Clamp Frame & Saddle (left)</p>  <p>PN: CFS-ADV-L Pcs. 1 set</p>	<p>3 Clamp Frame & Saddle (right)</p>  <p>PN: CFS-ADV-R Pcs. 1 set</p>	<p>4 Button Head Bolt 30mm</p>  <p>PN: M6x30BHCSZP Pcs. 2</p>	<p>5 Button Head Bolt 20mm</p>  <p>PN: M6x20BHCSZP Pcs. 2</p>	<p>6 Steel Bar End</p>  <p>PN: BESF Pcs. 2</p>	<p>7 Bar End Cap</p>  <p>PN: BEC2 Pcs. 2</p>	<p>8 Flat Head Bolt 30mm</p>  <p>PN: M8x30FHCSZP Pcs. 2</p>
<p>9 Spacer</p>  <p>PN: SP12-21 Pcs. 2</p>	<p>10 Flat Head Bolt 40mm</p>  <p>PN: M8x40FHCSZP Pcs. 2</p>	<p>11 Spacer 10mm</p>  <p>PN: BSSRT10 Pcs. 2</p>	<p>12 Flat Head Bolt 20mm</p>  <p>PN: M8x20FHCSZP Pcs. 2</p>				

Recommended Torque Settings	
M6	10 Nm (7.4 lbf ft)
M8	20 Nm (14.8 lbf ft)
M12 (item 6)	21Nm (15.5 lbf ft)

CAUTION:

Installation of the handguard is safety-relevant work and can be complicated. We recommend the installation be performed by a motorcycle service technician. Rideworx accepts no liability for damages caused by improper mounting. All screws, bolts and nuts, including all replacement hardware provided by Rideworx, should be tightened to the torque specified in the table. After the first 50km of riding check all screws, bolts and nuts are tightened to the correct torque. We recommend a medium strength liquid thread lock product on all fasteners.

WARNING:

Check operation of all handlebar controls, specifically the throttle, front brake, kill switch and clutch to ensure they are operating correctly and are in accordance with the OEM specifications. Do not ride the motorcycle if any controls are not operating correctly or if rear view mirror vision is obscured. Check periodically that all bolts are tight.



RIDEWORX

Phone: +61 (0)2 4271 8244
Email: info@barkbusters.net
Web: www.barkbusters.net

Barkbusters

Disclaimer:

A failure to follow these fitting instructions could cause serious injury, death or property damage. These handguards are intended solely for use with motorcycles/ATV/snowmobiles/scooters that have not been modified. They are not designed to prevent injury or death while riding or in an accident or crash. The user must ensure that all controls are free of the handguards every time that they ride. By installing and/or using this product you acknowledge that you accept these terms and have followed the fitting instructions.

Installation to a Handlebar with Bar End Weight / Cap

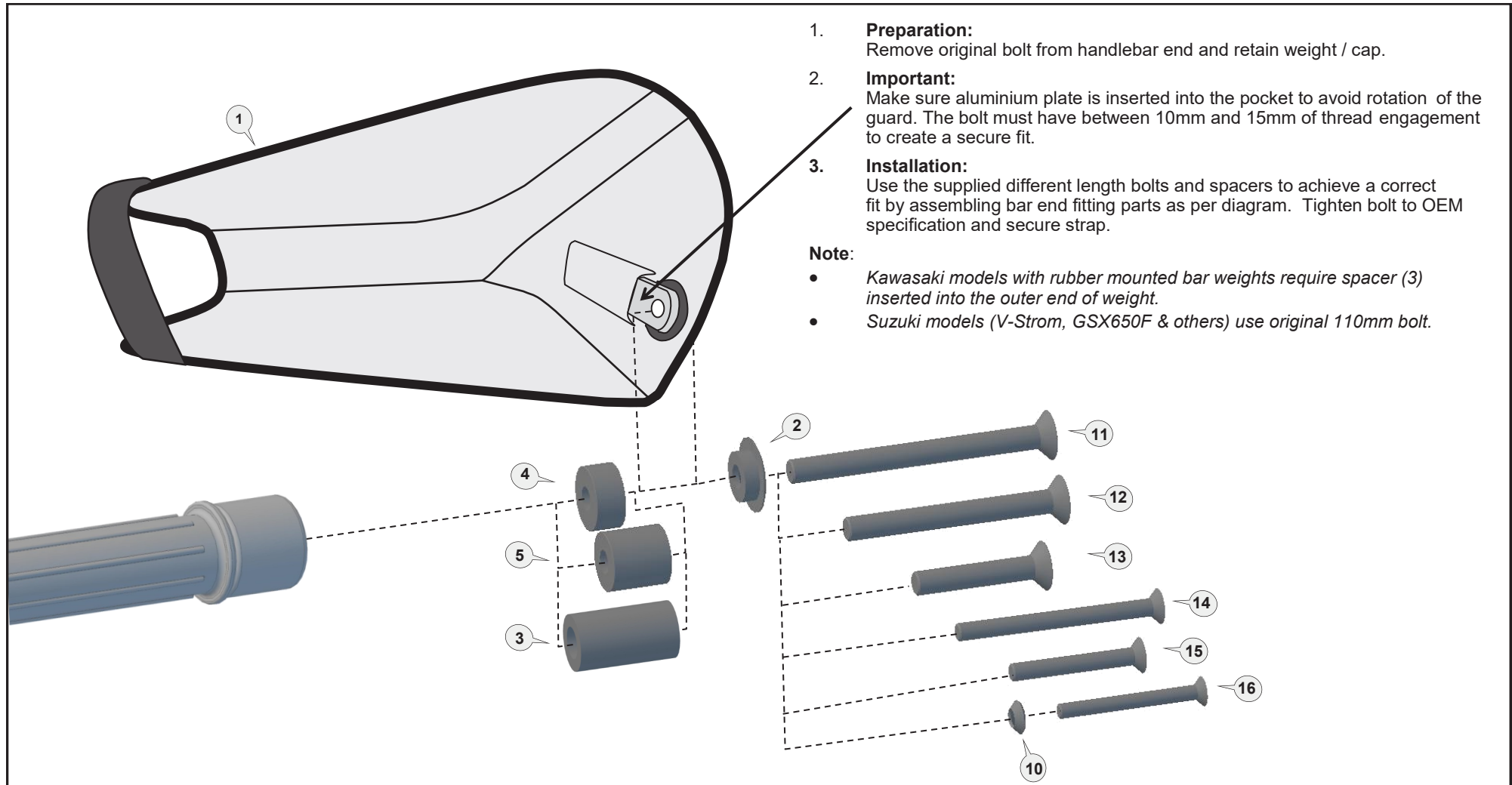

Installation to a Hollow Handlebar

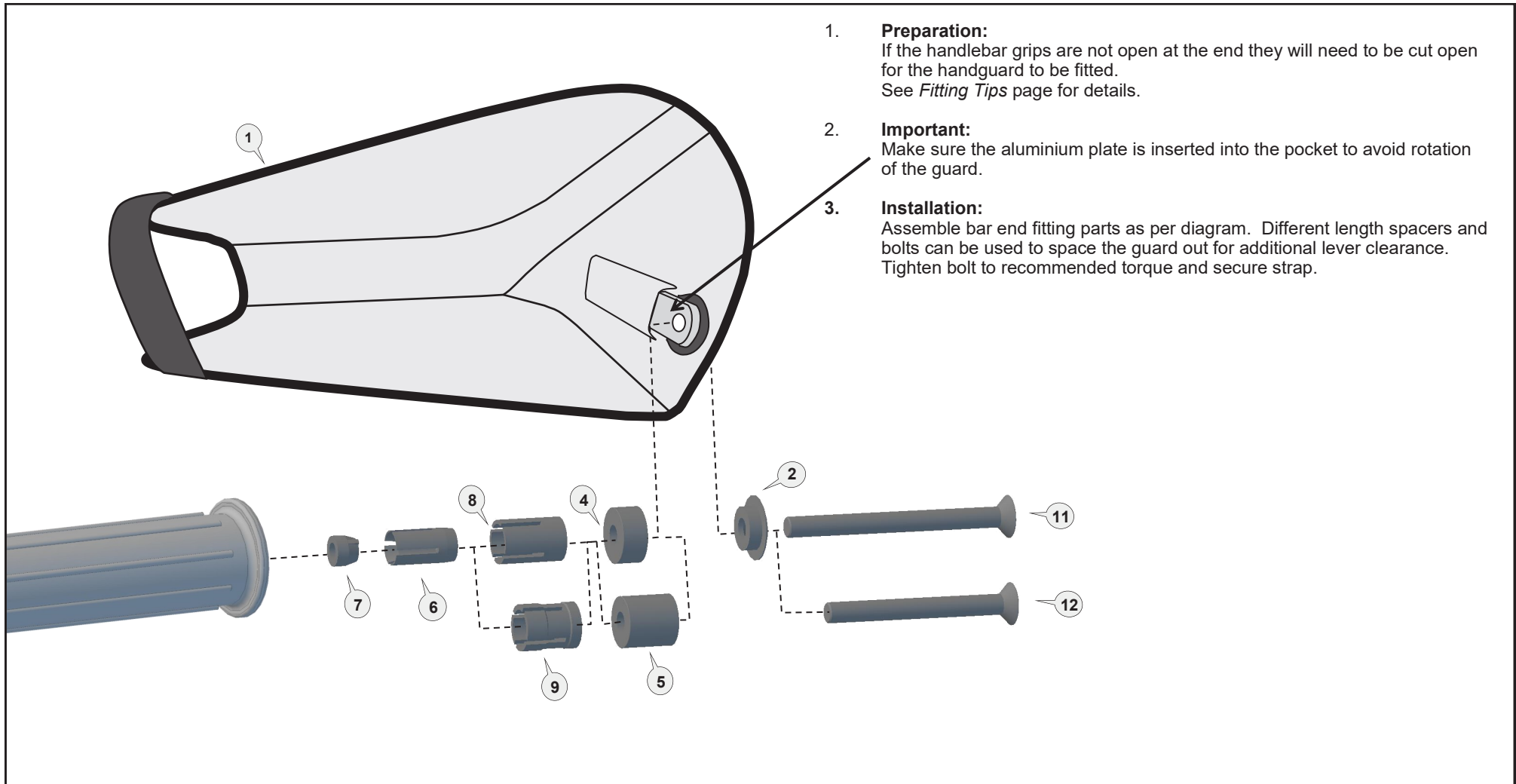



www.barkbusters.net

FITTING INSTRUCTIONS for... BBZ Fabric Guards

FITTING TIPS

- The Barkbusters BBZ fabric handguard is designed to flex around the windscreen / fairing if it makes contact when the steering is at full lock.
- **Closed Grip Preparation:**
If the handlebar grips are not open at the end they will need to be cut open for the guard to be installed. Use a sharp knife to cut a hole in the end of each handgrip. On the right side the hole size should be neat and no smaller than the inside diameter of the throttle tube. Loosen the throttle assembly to move it outward about 20mm. Roll back the end of the grip and use a hacksaw to carefully cut off the end cap of the plastic throttle tube. Do not remove more than 3mm and take care not to cut the underlying handlebar. Before refitting, remove any burrs that could restrict throttle movement.
- **Installation over Two Point Mount Aluminium Backbone** (sold separately):
Remove backbone from handlebar and remove plastic guard from backbone, if installed. Insert appropriate length bolt through collar (2), BBZ Guard (1) and outer end of backbone. Fit expander parts and insert into handlebar or attach to threaded bar end, as required: (spacers and aluminium plate not required). Re-install backbone and tighten bolts. Secure strap.
- **Honda models with rotating bar weight.**
The bar weight on many Honda models can rotate. If you experience rotation (up and down) of the handguard we recommend removal of the weight and internal handlebar parts to create a hollow handlebar. After the below removal procedure has been performed the guard can be installed using the hollow handlebar installation procedure.
Left side, roll back hand grip and depress the two retaining clips through the holes in the handlebar with a screwdriver. There is one top and one bottom. To access holes on right side, unscrew throttle housing and separate the two halves enough to slide the twist grip in from the end. Leave handlebar weight connected to the internal weight to help with removing the internal parts. Pull on weight while pressing clips through hole. See pictures below.



Left



Right

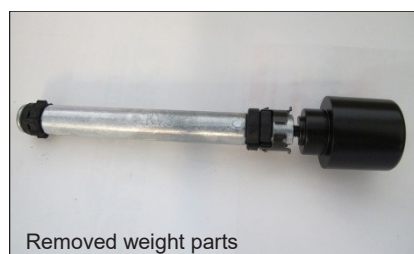

Removed weight parts



Optional flap to assist with fitting and blocking wind.

Use the strap to secure handguard around the handlebar at the inside of the controls.

1 Fabric Guard



PN: BZ1
Pcs. 1 Left & 1 Right

2 Collar



PN: COLLAR-M8FH
Pcs. 2

3 Spacer



PN: SP-25-14-8
Pcs. 2

4 Spacer



PN: BSSRT10
Pcs. 2

5 Spacer



PN: BSSRT20
Pcs. 2

6 Expander



PN: BBE14A
Pcs. 2

7 Taper Nut



PN: NUT12
Pcs. 2

8 Collet



PN: COLLET14-16
Pcs. 2

9 Collet



PN: COLLET14-18
Pcs. 2

10 Cupped Washer



PN: M5CW
Pcs. 2

11 Flat Head Bolt 90mm



PN: M8x90FHCSZP
Pcs. 2

12 Flat Head Bolt 75mm



PN: M8x75FHCSZP-FT
Pcs. 2

13 Flat Head Bolt 45mm



PN: M8x45FHCSZP
Pcs. 2

14 Flat Head Bolt 70mm



PN: M6x70FHCSZP
Pcs. 2

15 Flat Head Bolt 45mm



PN: M6x45FHCSZP
Pcs. 2

16 Flat Head Bolt 50mm



PN: M5x50FHCSZP
Pcs. 2

NOTE:

Installation of the handguard is safety-relevant work and can be complicated. We recommend the installation be performed by a motorcycle service technician.

WARNING:

Check operation of all handlebar controls, specifically the throttle, front brake, kill switch and clutch to ensure they are operating correctly and are in accordance with the OEM specifications. This check should be performed with the steering straight and also when it is at left and right full lock. If the lever end touches the guard extra spacers may be required at the handlebar end mounting point. On some motorcycles the guard may touch near the levers pivot point and hinder its function. If this occurs reposition the handguard to avoid interference. Do not ride the motorcycle with the guards installed if any controls are not operating correctly. Check periodically that all bolts are tight.

CAUTION:

Rideworx accepts no liability for damages caused by improper mounting. All bolts including all provided by Rideworx, should be tightened to the torque settings recommended by your motorcycle's manufacturer. If unavailable, use torque settings in the table provided. After the first 50km of riding check all bolts are tightened to the correct torque. We recommend a medium strength liquid thread lock product on all fasteners.

Recommended Torque Settings	
M5	6 Nm (4.4 lbf ft)
M6	10 Nm (7.4 lbf ft)
M8	20 Nm (14.8 lbf ft)



Phone: +61 (0)2 4271 8244
Email: info@barkbusters.net
Web: www.barkbusters.net



Disclaimer:

A failure to follow these fitting instructions could cause serious injury, death or property damage. These handguards are intended solely for use with motorcycles/ATV/snowmobiles/scooters that have not been modified. They are not designed to prevent injury or death while riding or in an accident or crash. The user must ensure that all controls are free of the handguards every time that they ride. By installing and/or using this product you acknowledge that you accept these terms and have followed the fitting instructions.