

FITTING INSTRUCTIONS
for...

- SUZUKI DL250 V-Strom ('17 on)
- SUZUKI DL1050 V-Strom('20 on)
- SUZUKI DL1050XT V-Strom ('20 on)

Preparation:

Remove original handlebar end weight and handguard (if installed). Loosen weight screw about three turns, tap screw head in to free up. Pull weight out while using an up and down movement to remove the complete assembly.

Fitting Procedure:

Fitting Procedure shown for the LEFT side

(repeat for right side with applicable parts)

Loosely assemble clamp (3) to the handlebar with applicable parts.

Loosely attach the handguard backbone with applicable parts to the handlebar end and also to the clamp.

Note: The preferred backbone position is horizontal when viewed from the side (see below).

Tighten all bolts in the following order (8), (7), then (5) and (6).



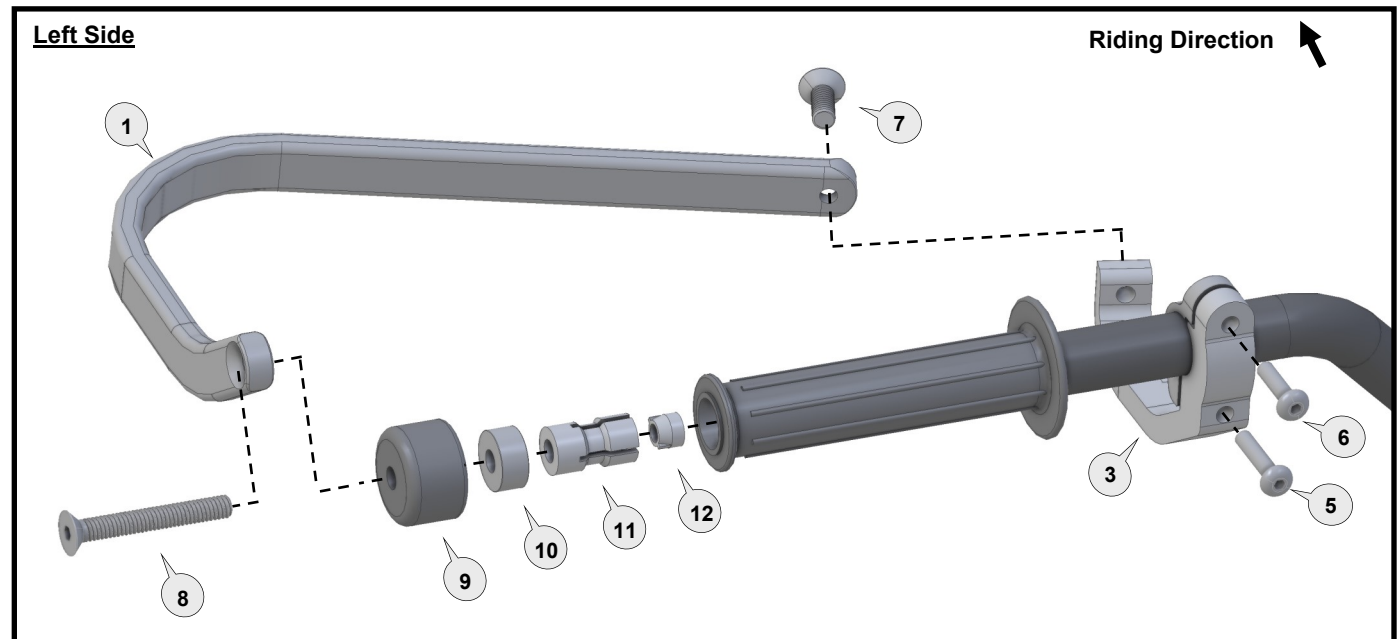



Use recommended torque specifications over page.

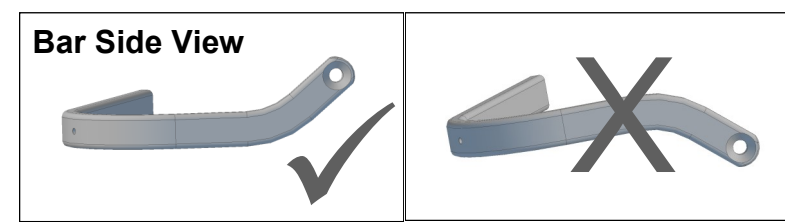

Personalise Your Protection
Guard options sold separately

JET	JET-003
VPS	VPS-003
Storm	STM-003
CARBON	BCF-003

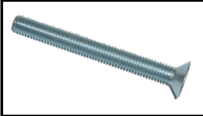

<p>1 Aluminium Bar LEFT</p>  <p>PN: BAR-V-036-L Pcs. 1 (Left)</p>	<p>2 Aluminium Bar RIGHT</p>  <p>PN: BAR-V-036-R Pcs. 1 (Right)</p>	<p>3 Clamp Frame & Saddle LEFT</p>  <p>PN: CFS-ADV-L Pcs. 1 Set (Left)</p>	<p>4 Clamp Frame & Saddle RIGHT</p>  <p>PN: CFS-ADV-R Pcs. 1 Set (Right)</p>	<p>5 Button Head Bolt 30mm</p>  <p>PN: M6X30BHCSZP Pcs. 2</p>	<p>6 Button Head Bolt 20mm</p>  <p>PN: M6X20BHCSZP Pcs. 2</p>	<p>7 Flat Head Bolt 20mm</p>  <p>PN: M8X20FHCSZP Pcs. 2</p>	<p>8 Flat Head Bolt 70mm</p>  <p>PN: M8X70FHCSZP Pcs. 2</p>
---	---	--	---	---	---	---	---

<p>9 Bar End Weight</p>  <p>PN: BEW35 Pcs. 2</p>	<p>10 Spacer 10mm</p>  <p>PN: BSSRT10 Pcs. 2</p>	<p>11 Bar End Expander</p>  <p>PN: BBE17 Pcs. 2</p>	<p>12 Taper Nut</p>  <p>PN: NUT12 Pcs. 2</p>
--	--	---	---

Recommended Torque Settings	
M6	10 Nm (7.4 lbf ft)
M8	20 Nm (14.8 lbf ft)



Email: info@barkbusters.net
Web: www.barkbusters.net



CAUTION:

Installation of the handguard is safety-relevant work and can be complicated. We recommend the installation be performed by a motorcycle service technician. Rideworx accepts no liability for damages caused by improper mounting. All screws, bolts and nuts, including all replacement hardware provided by Rideworx, should be tightened to the torque specified in the table. After the first 50km of riding check all screws, bolts and nuts are tightened to the correct torque. We recommend a medium strength liquid thread lock product on all fasteners.

WARNING:

Check operation of all handlebar controls, specifically the throttle, front brake, kill switch and clutch to ensure they are operating correctly and are in accordance with the OEM specifications. Do not ride the motorcycle if any controls are not operating correctly or if rear view mirror vision is obscured. Check periodically that all bolts are tight.

Disclaimer:

A failure to follow these fitting instructions could cause serious injury, death or property damage. These handguards are intended solely for use with motorcycles/ATV/snowmobiles/scooters that have not been modified. They are not designed to prevent injury or death while riding or in an accident or crash. The user must ensure that all controls are free of the handguards every time that they ride. By installing and/or using this product you acknowledge that you accept these terms and have followed the fitting instructions.

Barkbusters
www.barkbusters.net

Esempio di aggancio
delle plastiche VPS

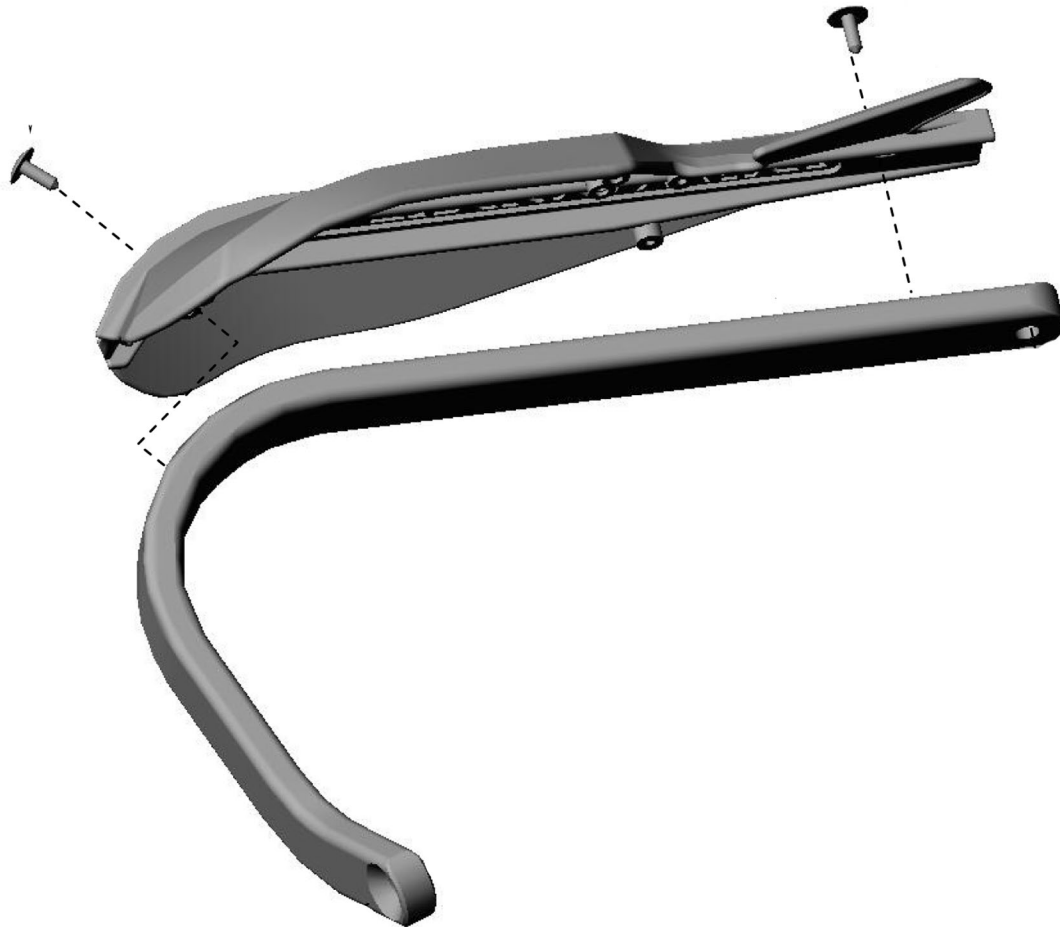

Phone: +61 (0)2 4271 8244
Email: info@barkbusters.net