

Barkbusters

www.barkbusters.net

**FITTING INSTRUCTIONS for
BMW G650X Challenge, Moto & Country**

Preparation

If bar end weights are installed they will need to be removed along with the threaded insert/nut to allow the handguard bar end fitting parts to be inserted. If the handlebar grips are not open at the end they will need to be cut open for the handguard to be fitted. Use a sharp knife to cut a hole in the end of each handgrip. On the right side the hole size should be neat and no smaller than the inside diameter of the throttle tube. Loosen the throttle assembly to move it outward about 20mm. Roll back the end of the grip and use a hacksaw to carefully cut off the end cap of the plastic throttle tube. Do not remove more than 3mm and take care not to cut the underlying handlebar. Before refitting, remove any burrs that could restrict throttle movement.

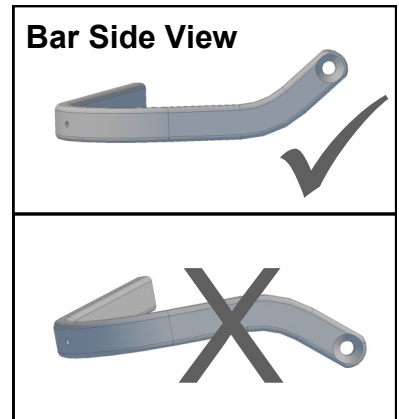
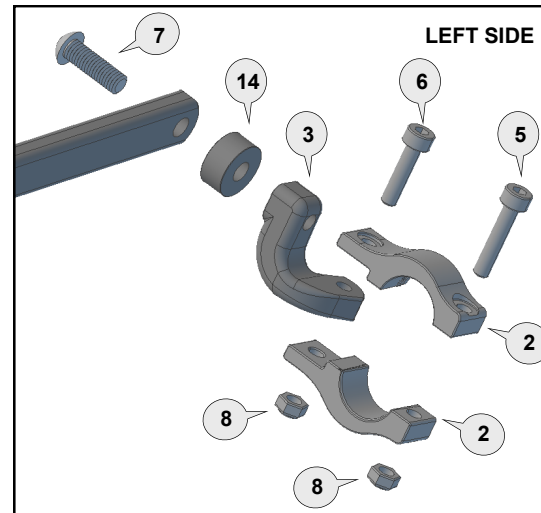
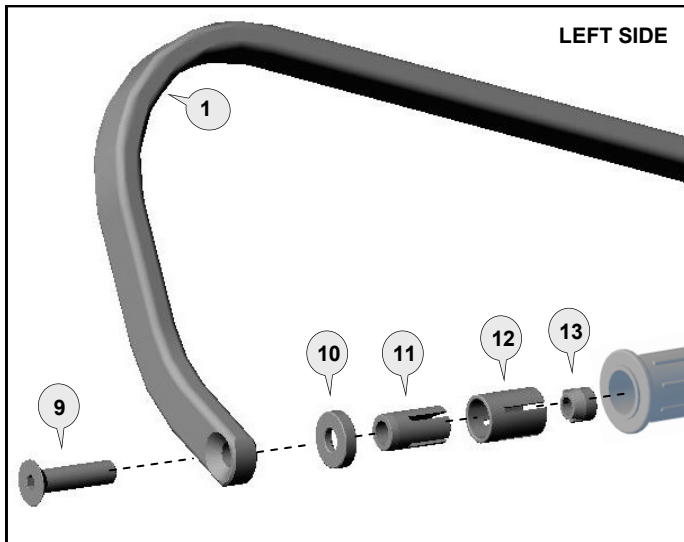

Important Fitting Procedure

Loosely assemble the clamp to the handlebar as per diagram. Attach the handguard backbone with applicable parts to the handlebar end and also to the clamp connector (3).

Position backbone so it is horizontal when viewed from the side and tighten bolt (9).

The clamp bolts must be tightened in the following order:

Tighten bolt (7) through the aluminium bar (1) and through spacer (14) to the clamp connector (3) of the clamp assembly.

Tighten bolt (6) to solidly lock the clamp connector (3) between the clamp saddles (2).

Tighten bolt (5) to secure the clamp assembly firmly to the handlebar.

Note: The clamp is designed to allow the nut on bolt (6) to pull into the recessed hole. This eliminates the need for a wrench after the bolt starts to tighten.













Personalise Your Protection

Guard options sold separately

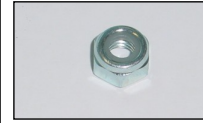
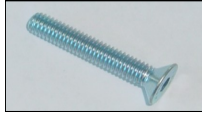
JET	JET-003
VPS	VPS-003
Storm	STM-003
CARBON	BCF-003



Phone: +61 (0)2 4271 8244
Email: info@barkbusters.net

<p>1 Aluminium Bar</p>  <p>PN: BAR-V-041 Pcs. 1 Left & 1 Right</p>	<p>2 Clamp Saddle</p>  <p>PN: CS-00 Pcs. 4 pieces</p>	<p>3 Connector Left</p>  <p>PN: CP8-L Pcs. 1</p>	<p>4 Connector Right</p>  <p>PN: CP8-R Pcs. 1</p>	<p>5 Socket Head Bolt 30mm</p>  <p>PN: M6x30SHCSZP Pcs. 2</p>	<p>6 Socket Head Bolt 25mm</p>  <p>PN: M6x25SHCSZP Pcs. 2</p>	<p>7 Button Head Bolt 35mm</p>  <p>PN: M8x35BHCSZP Pcs. 2</p>	<p>8 Nylock Nut 6mm</p>  <p>PN: M6LN Pcs. 4</p>
<p>9 Flat Head Bolt 45mm</p>  <p>PN: M8x45FHCSZP Pcs. 2</p>	<p>10 Collar</p>  <p>PN: BBEC5M Pcs. 2</p>	<p>11 Expander</p>  <p>PN: BBE14A Pcs. 2</p>	<p>12 Collet</p>  <p>PN: COLLET14-16 Pcs. 2</p>	<p>13 Taper Nut</p>  <p>PN: NUT12 Pcs. 2</p>	<p>14 Spacer 10mm</p>  <p>PN: BSSRT10 Pcs. 2</p>		

Recommended Torque Settings	
M6	10 Nm (7.4 lbf ft)
M8	20 Nm (14.8 lbf ft)

CAUTION:

Installation of the handguard is safety-relevant work and can be complicated. We recommend the installation be performed by a motorcycle service technician. Rideworx accepts no liability for damages caused by improper mounting. All screws, bolts and nuts, including all replacement hardware provided by Rideworx, should be tightened to the torque specified in the below table. After the first 50km of riding check all screws, bolts and nuts are tightened to the correct torque. We recommend a medium strength liquid thread lock product on all fasteners.

WARNING:

It is important there is a working clearance (approx 3mm) between the throttle grip end and the handguard to ensure a free closing throttle. Check operation of all handlebar controls, specifically the throttle, front brake, kill switch and clutch to ensure they are operating correctly and are in accordance with the OEM specifications. Do not ride the motorcycle if any controls are not operating correctly. Check periodically that all bolts are tight.



Phone: +61 (0)2 4271 8244
Email: info@barkbusters.net
Web: www.barkbusters.net

Barkbusters

Disclaimer:

A failure to follow these fitting instructions could cause serious injury, death or property damage. These handguards are intended solely for use with motorcycles/ATV/snowmobiles/scooters that have not been modified. They are not designed to prevent injury or death while riding or in an accident or crash. The user must ensure that all controls are free of the handguards every time that they ride. By installing and/or using this product you acknowledge that you accept these terms and have followed the fitting instructions.

Option for fitting with **Single Point Handlebar Mount**

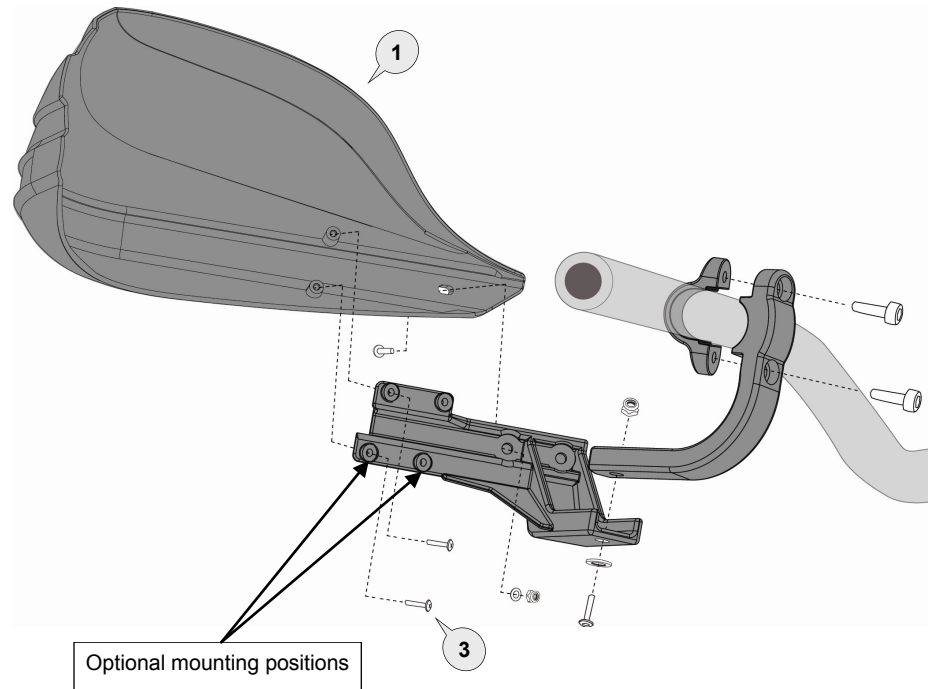

Option for fitting with **Aluminium Backbone**

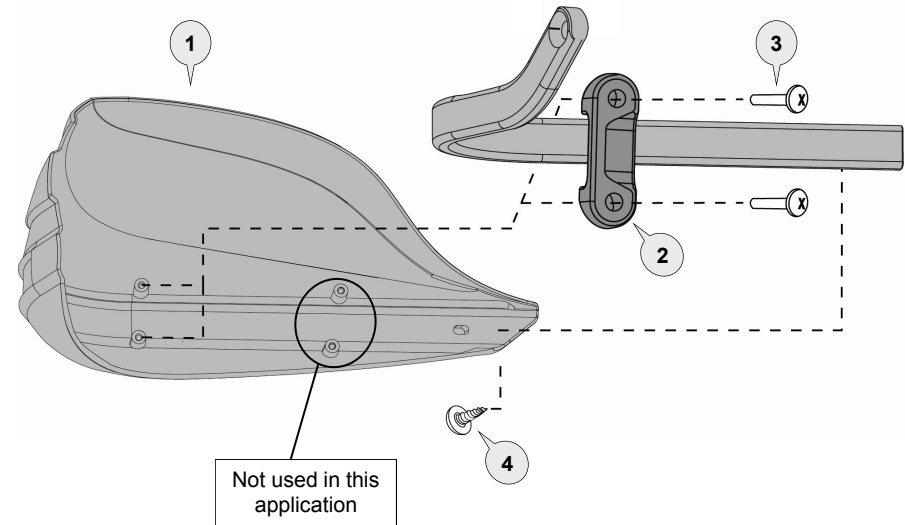



CAUTION:

Installation of the handguard is safety-relevant work and can be complicated. We recommend the installation be performed by a motorcycle service technician. Rideworx accepts no liability for damages caused by improper mounting. All screws, bolts and nuts, including all replacement hardware provided by Rideworx, should be tightened to the torque specified in the below table. After the first 50km of riding check all screws, bolts and nuts are tightened to the correct torque. We recommend a medium strength liquid thread lock product on all fasteners.

WARNING:

Check operation of all handlebar controls, specifically the throttle, front brake, kill switch and clutch to ensure they are operating correctly and are in accordance with the OEM specifications. Do not ride the motorcycle if any controls are not operating correctly. Check periodically that all bolts are tight.

Disclaimer:

A failure to follow these fitting instructions could cause serious injury, death or property damage. These handguards are intended solely for use with motorcycles/ATV/snowmobiles/scooters that have not been modified. They are not designed to prevent injury or death while riding or in an accident or crash. The user must ensure that all controls are free of the handguards every time that they ride. By installing and/or using this product you acknowledge that you accept these terms and have followed the fitting instructions.



Phone: +61 (0)2 4271 8244
Email: info@barkbusters.net
Web: www.barkbusters.net

