

## Preparation: Handlebar Weight Removal

Remove original handlebar end weight with internal weight parts.

To ensure a secure handguard mount, it is important to remove the original internal bar weight parts. To make it easier to remove, spray a lubricant into the inside of the handlebar and allow some time to soak into the rubber grommet around the internal weight. Leave handlebar weight connected to the internal weight to help with removing the internal parts. Pull on weight while rotating until it comes free. This process may require substantial force. See images to right.

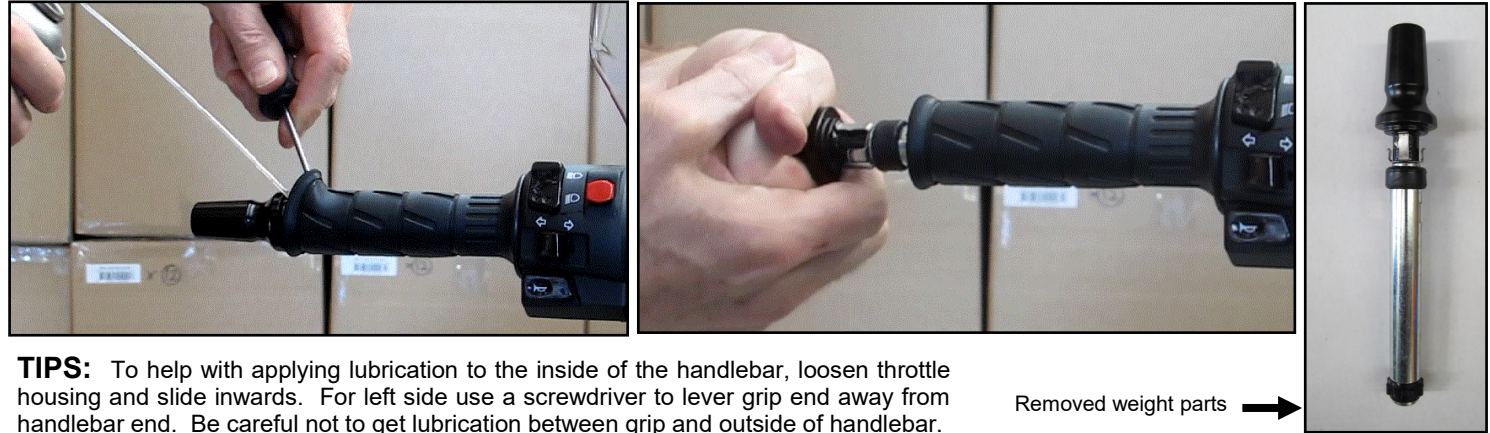

**TIPS:** To help with applying lubrication to the inside of the handlebar, loosen throttle housing and slide inwards. For left side use a screwdriver to lever grip end away from handlebar end. Be careful not to get lubrication between grip and outside of handlebar.

Removed weight parts →

## Fitting Procedure:

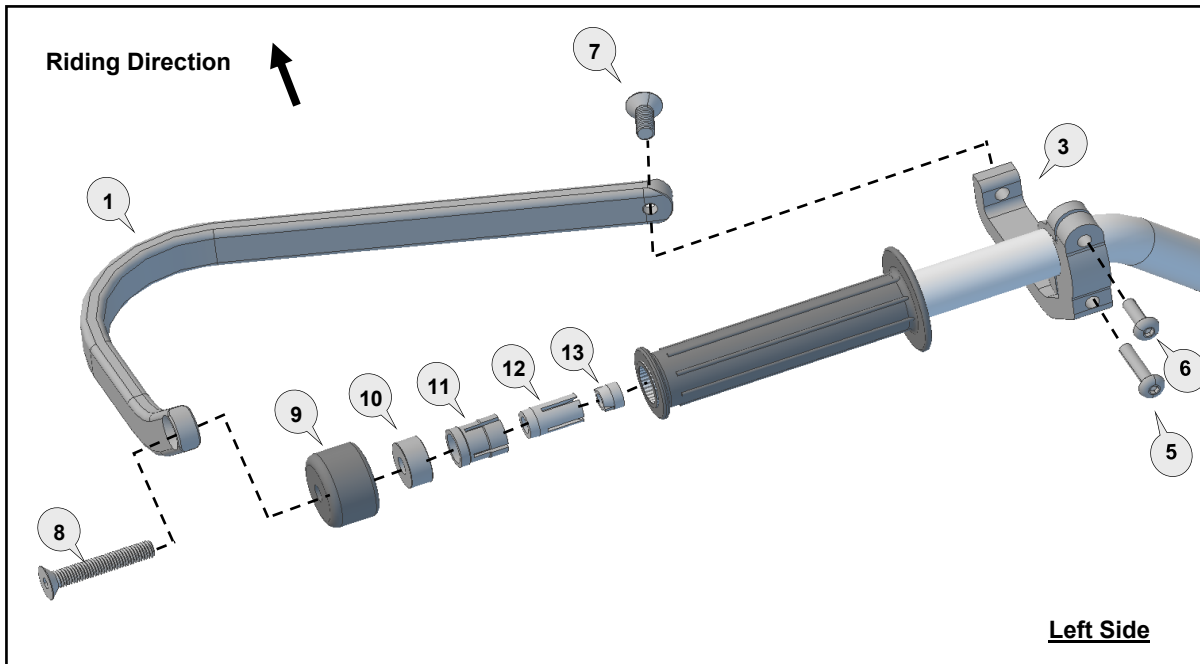

### Fitting Procedure shown for the LEFT side (repeat for right side with applicable parts)

- Loosely assemble clamp (3) to the handlebar with applicable parts.
  - Loosely attach the handguard backbone with applicable parts to the handlebar end and also to the clamp.
- Note:** The preferred backbone position is horizontal when viewed from the side.
- Tighten all bolts in the following order (8), then (7), then (5 and 6).
  - Use recommended torque specifications over page.



Phone: +61 (0)2 4271 8244  
Email: info@barkbusters.net

**1** Aluminium Bar



PN: BAR-V036-L  
Pcs. 1 (Left)

**2** Aluminium Bar



PN: BAR-V036-R  
Pcs. 1 (Right)

**3** Clamp Frame & Saddle (left)



PN: CFS-ADV-L  
Pcs. 1 set

**4** Clamp Frame & Saddle (right)



PN: CFS-ADV-R  
Pcs. 1 set

**5** Button Head Bolt 30mm



PN: M6x30BHCSZP  
Pcs. 2

**6** Button Head Bolt 20mm

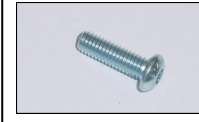

PN: M6x20BHCSZP  
Pcs. 2

**7** Flat Head Bolt 20mm



PN: M8x20FHCSZP  
Pcs. 2

**8** Flat Head Bolt 65mm



PN: M8x65FHCSZP  
Pcs. 2

**9** Bar End Weight



PN: BEW35  
Pcs. 2

**10** Spacer 10mm



PN: BSSRT10  
Pcs. 2

**11** Collet



PN: COLLET14-18  
Pcs. 2

**12** Expander 14mm



PN: BBE14A  
Pcs. 2

**13** Taper Nut

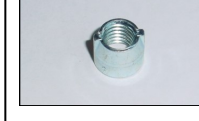

PN: NUT12  
Pcs. 2

**Personalise Your Protection**  
Guard options sold separately

**JET** JET-003  
**VPS** VPS-003  
**Storm** STM-003  
**CARBON** BCF-003

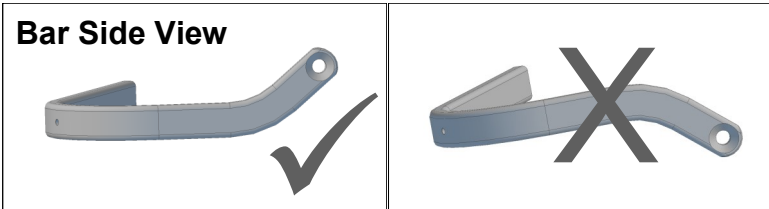

Recommended Torque Settings	
M6	10 Nm (7.4 lbf ft)
M8	20 Nm (14.8 lbf ft)



Phone: +61 (0)2 4271 8244  
Email: [info@barkbusters.net](mailto:info@barkbusters.net)  
Web: [www.barkbusters.net](http://www.barkbusters.net)

**Barkbusters**

**CAUTION:**

Installation of the handguard is safety-relevant work and can be complicated. We recommend the installation be performed by a motorcycle service technician. Rideworx accepts no liability for damages caused by improper mounting. All screws, bolts and nuts, including all replacement hardware provided by Rideworx, should be tightened to the torque specified in the table. After the first 50km of riding check all screws, bolts and nuts are tightened to the correct torque. We recommend a medium strength liquid thread lock product on all fasteners.

**WARNING:**

Check operation of all handlebar controls, specifically the throttle, front brake, kill switch and clutch to ensure they are operating correctly and are in accordance with the OEM specifications. Do not ride the motorcycle if any controls are not operating correctly or if rear view mirror vision is obscured. Check periodically that all bolts are tight.

**Disclaimer:**

A failure to follow these fitting instructions could cause serious injury, death or property damage. These handguards are intended solely for use with motorcycles/ATV/snowmobiles/scooters that have not been modified. They are not designed to prevent injury or death while riding or in an accident or crash. The user must ensure that all controls are free of the handguards every time that they ride. By installing and/or using this product you acknowledge that you accept these terms and have followed the fitting instructions.

## ESEMPIO DI AGGANCIAMENTO DELLE PLASTICHE JET

