

**Dealers:** If installing the Chrome Lower Kit for a customer please give them this manual. It contains information needed to properly maintain and use this product.

### Attention





Special notes and cautionary measures which can prevent damage to the accessory or motorcycle.

### Note:



Tips for facilitation of operation, control and adjustment, as well as maintenance work.

 N76602 Chrome Lower are engineered to install to a National Cycle QuickSet 4 Mount Kit Q301. You must have this Mount Kit (SwitchBlade windshield mount kit) mounted on your motorcycle or have purchased this kit prior to installing the Chrome Lower.

 When mounting the chrome lowers re-use all hardware from your QuickSet 4 Mount Kit.



Proper tightening of this assembly is critical. Use a Torque Wrench! Follow this procedure! Correct assembly of this kit will provide years of reliable service.

### Parts List for N76602

| <u>INDEX</u> | <u>DESCRIPTION</u>               | <u>QTY.</u> |
|--------------|----------------------------------|-------------|
| 1            | 30-307662-000 Chrome Lower Left  | 1           |
| 2            | 30-307663-000 Chrome Lower Right | 1           |

### PREPARATION

1. Locate the Installation Manual 10-112208-000 from the QuickSet 4 Mount Kit. If you no longer have this manual go to: [www.nationalcycle.com/support.html](http://www.nationalcycle.com/support.html) to locate the manual.

2. Position the motorcycle securely on its stand or a work stand.

3. Cover the front fender and fuel tank with a suitable cloth to avoid scratches from dropped tools.

4. If you have a QuickSet 4 Mount Kit on the motorcycle, remove the Kit (**5mm Hex Key**).

5. Remove the small Lower Spool from the Mount Bracket (**4mm Hex Key**). **Figure 1**

 All Hardware will be re-used.



4mm Hex Key Wrench and Hex Bit Socket

5mm Hex Key Wrench and Hex Bit Socket

Torque Wrench that accurately measures to 50 inch pounds. (4.17ft/lbs) (5.7 Nm)

Thread Lock

Installation Manual 10-112208-000 from QuickSet4 Mount Kit. If you no longer have this manual go to:

[www.nationalcycle.com/support.html](http://www.nationalcycle.com/support.html)

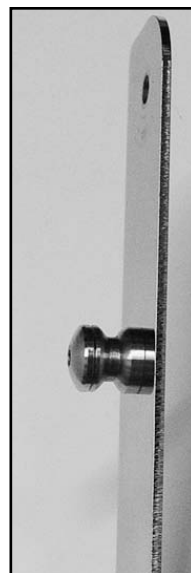

Figure 1

## INSTALLATION of N76602

1. Push the large Upper Cap Bushing into the large Upper Spool so the **thick side** of the spool is near the head of the Upper Cap Bushing. **Figure 2**

2. Repeat for the Lower Spool. **Figure 3**

3. Select the right side Chrome Lower and right side Mount Bracket.

4. Apply Thread Lock to stud on Mount Bracket. Assemble the Chrome Lower To the Mount Bracket with Small Spool assembly. **Figure 4**

5. Install the right side Chrome Lower assembly to the right side of the motorcycle. Start the M8-40 Screw from Kit Q301 through the Upper Spool assembly, the Chrome Lower Bracket assembly, Bushing and then into the upper hole in fork (**5mm Hex Key**). **Figure 5**

6. Install the lower M8-16 Screw (**5mm Hex Key**). **Figure 5**

7. Repeat steps 1 through 6 on left fork.



8. Tighten M8 Screws to 15 ft/lbs (21Nm). Tighten the small Lower Spool to 50 INCH POUNDS (5.7 Nm) (4.17ft/lbs) (Torque Wrench).

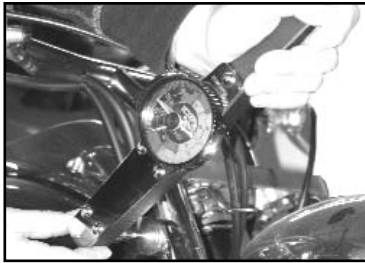

Figure 2

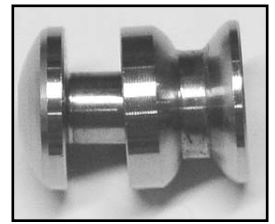

Figure 3

*Thick Side of Spool  
is near the head of  
the Cap Bushing.*

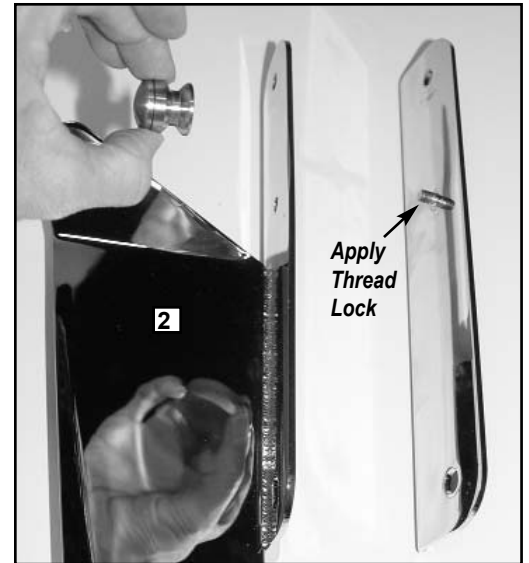

Figure 4

*Apply  
Thread  
Lock*

*Mount Bracket*

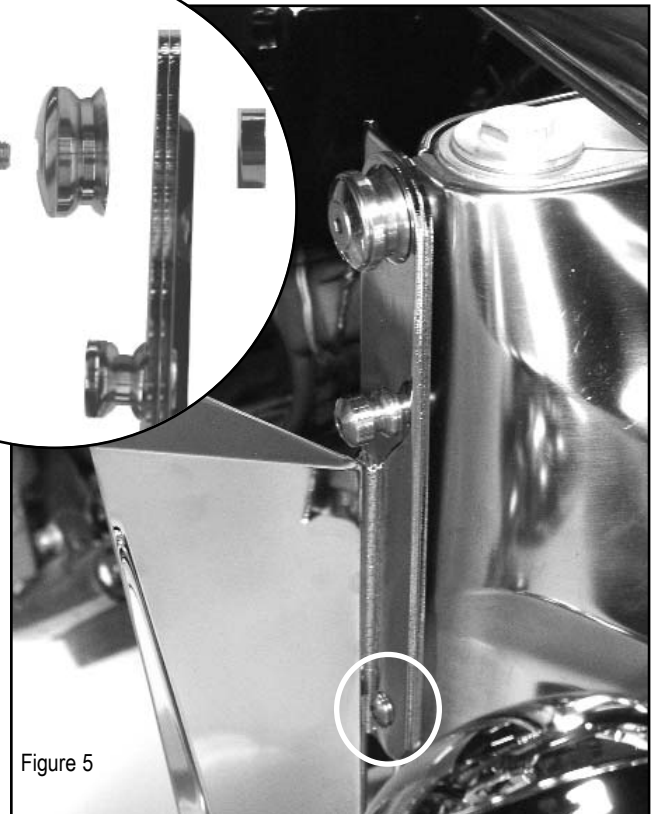
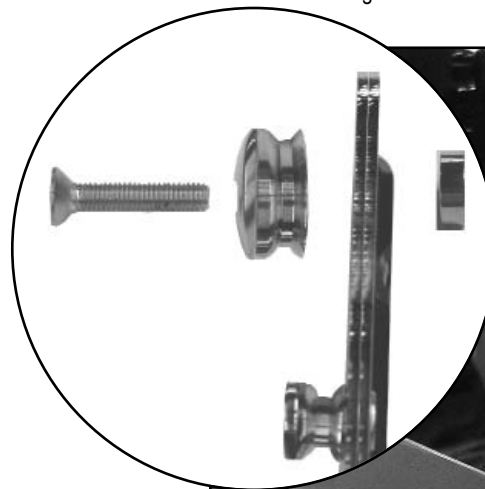

Figure 5

## MAINTENANCE

The high quality chrome finish of your National Cycle Chrome Lower can be maintained with any quality chrome cleaner and / or polish applied with a soft cloth.

Check hardware for tightness regularly. Never ride with loose mounting hardware. Check to be sure your Chrome Lower do not contact any part of the motorcycle at a full turn left and right. Correct any problem before using the motorcycle.

National Cycle, Inc. Maywood, IL 60153-0158 USA 708-343-0400 / Fax: 708-343-0625

[www.nationalcycle.com/support.html](http://www.nationalcycle.com/support.html)

Page 2 of 2 10-110765-000 08/04