

**Nonshock GPS-Halter Cockpit TRIUMPH Speed Triple '08 –**  
Nonshock Cockpit GPS-Mount TRIUMPH Speed Triple '08 –

**Montagehinweise**

Alle vom Motorrad gelösten Schrauben sind gemäß Herstellerangaben wieder zu montieren, oder mit von SW-MOTECH gelieferten Schrauben zu ersetzen. Falls nicht anderweitig definiert, diese Schrauben nach Tabelle anziehen.

<b>M5</b>	<b>5,5 Nm</b>
<b>M6</b>	<b>9,6 Nm</b>
<b>M8</b>	<b>23 Nm</b>

Gegebenenfalls Schrauben mit flüssiger Schraubensicherung einkleben.

Prüfen Sie nach 50 km alle Verbindungen auf festen Sitz.

SW-MOTECH GmbH & Co. KG  
Ernteweg 8/10  
35282 Rauschenberg  
Germany

Tel. +49 (0) 64 25/8 16 8-00  
Fax +49 (0) 64 25/8 16 8-10

info@sw-motech.com  
www.sw-motech.com

**Mounting Instructions**













SW-MOTECH products should be installed by a qualified, experienced motorcycle technician. If you are unsure of your ability to properly install a product, please have the product installed by your local motorcycle dealer. SW Motech takes no responsibility for damages caused by improper installation.

All screws, bolts and nuts, including all replacement hardware provided by SW-MOTECH, should be tightened to the torque specified in the OEM maintenance manual for your motorcycle. If no torque specifications are provided in the OEM maintenance manual, the following torques may be used:

<b>M5</b>	<b>5,5 Nm</b>
<b>M6</b>	<b>9,6 Nm</b>
<b>M8</b>	<b>23 Nm</b>

All screws, bolts and nuts should be checked after driving the first 50 km to ensure that all are tightened to the proper torque.

Medium strength liquid thread-locker (i.e., "Loctite") should be used to secure all screws, bolts and nuts.

<p><b>1</b> Lenkerbasis Handlebar Base</p>  <p>GPS.07.561.001 <b>02</b> Anzahl/ Pcs. 1</p>	<p><b>5</b> GPS-Trägerblech GPS-Bracket</p>  <p>GPS.00.085.006 <b>06</b> Anzahl/ Pcs. 1</p>	<p><b>9</b> Linsenkopfschraube Lenshead Screw</p>  <p>schwarz/black M5 x 16 DIN 7380 Anzahl/ Pcs. 4</p>
<p><b>2</b> Innensechskantschraube, kurzer Kopf Hexagon Socket Screw, short Head</p>  <p>schwarz/black Festigkeitsklasse 10.9 M8 x 45 DIN 6912 Anzahl/ Pcs. 4</p>	<p><b>6</b> Verbindungsblech Connector Lug</p>  <p>GPS.00.085.003 <b>00</b> Anzahl/ Pcs. 2</p>	<p><b>10</b> Fixierblech Fixing Lug</p>  <p>GPS.00.085.004 <b>01</b> Anzahl/ Pcs. 2</p>
<p><b>3</b> Unterlegscheibe Washer</p>  <p>schwarz/black A 8,4 DIN 125 Anzahl/ Pcs. 4</p>	<p><b>7</b> Gummitülle Rubber Element</p>  <p>GT.00.12H3472 Anzahl/ Pcs. 4</p>	<p><b>11</b> Linsenkopfschraube Lenshead Screw</p>  <p>schwarz/black M6 x 12 ISO 7380 Anzahl/ Pcs. 2</p>
<p><b>4</b> Distanzbuchse Spacer</p>  <p>Da:13 Di:8,4 h:13 Anzahl/ Pcs. 4</p>	<p><b>8</b> Distanzbuchse Spacer</p>  <p>Da:8 Di:5,4 h:9 Anzahl/ Pcs. 4</p>	<p><b>12</b> Sperrzahnscheibe Teeth Lock Washer</p>  <p>schwarz/black A 6,4 DIN 6797 Anzahl/ Pcs. 2</p>

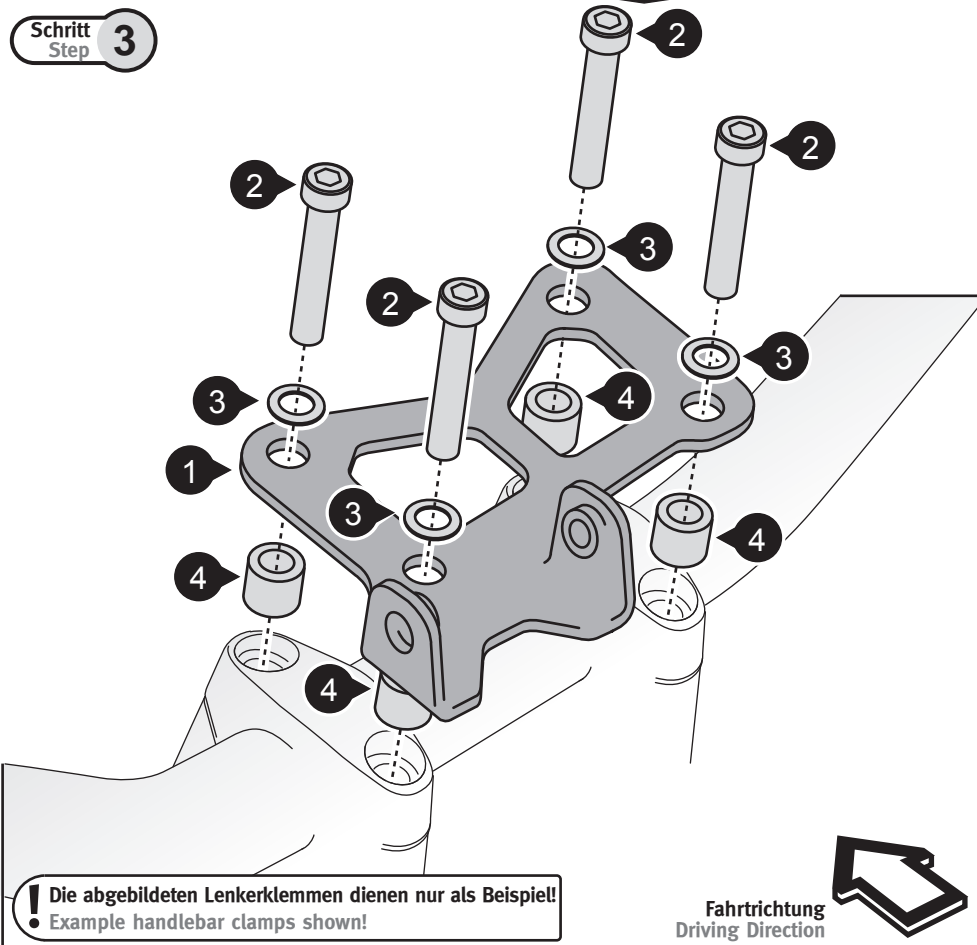
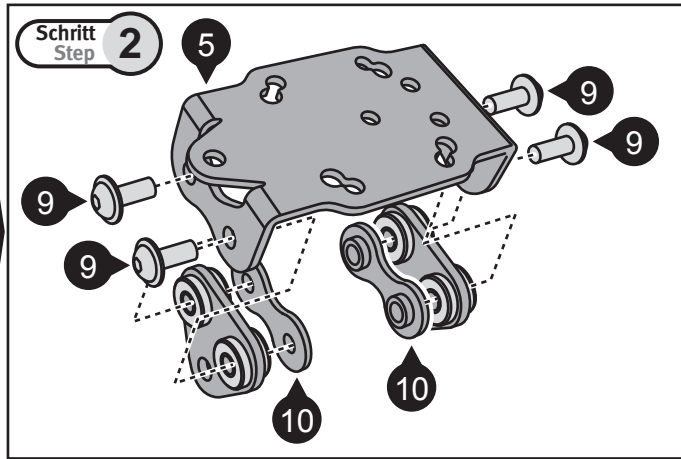
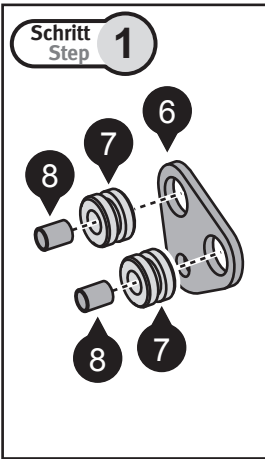

**ACHTUNG:** Wird der GPS-Halter zusammen mit einer SW-MOTECH Lenkererhöhung montiert, ist es notwendig, die zur Montage am Motorrad benötigten Schrauben durch längere Schrauben (**Festigkeitsklasse 10.9**) zu ersetzen. Die für Ihre Lenkererhöhung passende Schraubenlänge entnehmen Sie bitte der Tabelle (**Schrauben über unsere Mailorder erhältlich**):

Lenkererhöhung 20 mm	> M8 x 65 DIN 6912 F 10.9
Lenkererhöhung 25 mm	> M8 x 70 DIN 6912 F 10.9
Lenkererhöhung 30 mm	> M8 x 75 DIN 6912 F 10.9

**ATTENTION:** If the GPS-Mount is mounted together with a SW-MOTECH handlebar riser, it is necessary to use longer screws (**strength class 10.9**) for mounting. The length of the screws for your handlebar riser can be found in the table below (**screws available by our mailorder**):

Hande Bar Riser 20 mm	> M8 x 65 DIN 6912 F 10.9
Hande Bar Riser 25 mm	> M8 x 70 DIN 6912 F 10.9
Hande Bar Riser 30 mm	> M8 x 75 DIN 6912 F 10.9

**INFORMATION**

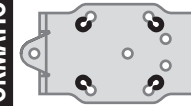

◀ **Standard AMPS-Lochmuster\* (horizontal)**  
Standard AMPS Horizontal Pattern\*  
für / for: TomTom Rider II, Garmin Zumo, Bags-Connection GPS / PDA Bags  
Ø 5,5 mm, L: 38 mm, h: 30 mm

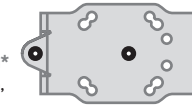

◀ **Garmin Street Pilot 2610 – 2720 (RAM)**  
Ø 5 mm, L: 48,4 mm

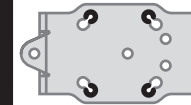

◀ **Standard AMPS-Lochmuster\* (vertikal)**  
Standard AMPS Vertical Pattern\*  
für / for: TomTom Rider II, Garmin Zumo, Bags-Connection GPS / PDA Bags  
Ø 5 mm, L: 30 mm, h: 38 mm

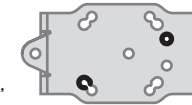

◀ **Garmin Quest Serie (RAM)**  
Garmin Quest Series (RAM)  
Ø 5 mm, L: 48,4 mm

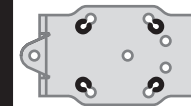

◀ **TomTom Rider I**  
Ø 3,5 mm, L: 35 mm, h: 30 mm

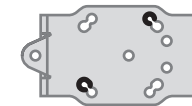

◀ **Garmin E-Trex Serie (RAM)**  
Garmin E-Trex Series (RAM)  
Ø 5 mm, L: 48,4 mm

\* Das universelle AMPS-Lochmuster ist kompatibel mit den meisten GPS-Systemen und Gerätehaltern.  
\* Universal AMPS hole pattern is compatible with the most devices or device holders.

