

ANBAUANLEITUNG

mounting instructions • instructions de montage • instrucciones de montaje • istruzioni di montaggio

BC.HTA.06.932.30000/B

beinhaltet • contains • contient • contiene • contiene

HTA.06.932.10000

HTA.06.932.11000

BC.HTA.00.677.10000L/B

BC.HTA.00.677.10000R/B

Numero di articolo: HTA.06.932.10000

Revisione: 00 · Data: 12 - 2022

Telaio portaborse SLC sinistro

 ~ 0.5 h.FACILE     DIFFICILE

ITALIANO - Grazie per aver scelto questo prodotto premium di SW-MOTECH. Per ulteriori informazioni (ad esempio per la compatibilità con i vari modelli), è possibile visitare il nostro shop online. I documenti necessari (ad esempio il permesso operativo generale) sono disponibili per il download.

Si prega di leggere attentamente le avvertenze di sicurezza e le istruzioni per il montaggio prima di montare e utilizzare il prodotto, al fine di evitare eventuali lesioni e danni. Conserva queste istruzioni per il montaggio come riferimento futuro.

Questo prodotto è stato sviluppato per veicoli in condizioni di fabbrica. La compatibilità con gli accessori originali o di altri produttori non può essere garantita.

Queste istruzioni per il montaggio sono state redatte in base alle nostre conoscenze attuali. Non sussistono pretese di correttezza giuridiche. Salvo errori ed omissioni. Ci riserviamo il diritto di apportare modifiche tecniche e di design. Copyright SW-MOTECH.

SIMBOLO DI SICUREZZA

 Questo simbolo di avvertenza è usato nelle presenti istruzioni di montaggio per segnalare pericoli mortali, rischio di lesioni o altri pericoli. Le parole "PERICOLO", "AVVERTENZA" o "ATTENZIONE" sono utilizzate con questo simbolo di avvertenza per trasmettere importanti istruzioni di sicurezza e informazioni relative al montaggio e all'uso di questo prodotto. Queste parole, utilizzate insieme al simbolo di avvertenza, significano:

 **PERICOLO:** indica una situazione di pericolo che, se non evitata, può causare morte o lesioni gravi!

 **AVVERTENZA:** indica una situazione di pericolo che, se non evitata, può causare morte o lesioni gravi!

 **ATTENZIONE:** indica una situazione di pericolo che, se non evitata, può provocare lesioni lievi o di entità moderata!

 **AVVISO:** indica informazioni importanti che non riguardano il rischio di morte o di lesioni (riguardano unicamente il rischio di danni materiali)!

INFORMAZIONI GENERALI

 **AVVERTENZA:** il montaggio e/o la manutenzione di questo prodotto richiedono competenze tecniche avanzate, strumenti adeguati e una buona conoscenza dell'uso e delle caratteristiche della strumentazione di montaggio. Per la vostra sicurezza, SW-MOTECH raccomanda di far eseguire il montaggio e/o la manutenzione presso un'officina specializzata e certificata.

 **AVVERTENZA:** se si decide di installare questo prodotto in autonomia, leggere attentamente le istruzioni di montaggio prima del montaggio e dell'uso e seguirle attentamente per evitare lesioni gravi o mortali. Durante il montaggio e l'uso, seguire anche tutte le istruzioni pertinenti contenute nel manuale del veicolo. SE NON SI COMPRENDONO TALI ISTRUZIONI, ANCHE SOLO IN PARTE, O SE SONO NECESSARI CHIARIMENTI, NON CERCARE DI MONTARE IL PRODOTTO IN AUTONOMIA, SENZA CHIEDERE IL SUPPORTO DI SW-MOTECH!

PREPARAZIONE: leggere attentamente le istruzioni per il montaggio e assicurarsi che siano disponibili tutti i componenti contenuti nella lista.

 **ATTENZIONE:** assicurarsi che il veicolo sia perfettamente fermo. Spegnerne il motore e togliere la chiave. Se necessario, lasciar raffreddare il motore/scarico. Scollegare la batteria quando si interviene sull'impianto elettrico. Usare esclusivamente strumenti idonei e indossare sempre occhiali e guanti protettivi durante le operazioni di montaggio e manutenzione. Chiedere aiuto a una seconda persona durante le fasi di montaggio e manutenzione.

MONTAGGIO: tutti i componenti e i collegamenti rimossi dal veicolo devono essere reinstallati secondo le specifiche del produttore del veicolo o sostituiti con componenti e attrezzatura forniti da SW-MOTECH.

 **AVVERTENZA:** fissare tutte le filettature con frenafili liquido a media resistenza, se non diversamente specificato.

 **PERICOLO:** le coppie di serraggio non definite da SW-MOTECH devono essere richieste al costruttore del veicolo o a un'officina certificata.

CONTROLLO DI FUNZIONALITÀ: dopo il montaggio, accertarsi che non ci siano parti mobili bloccate e che il funzionamento del veicolo non sia disturbato. I cavi e i tubi flessibili non devono essere danneggiati e/o schiacciati.

 **AVVERTENZA:** eseguire un controllo completo delle funzioni prima di mettersi alla guida. Controllare la coppia di serraggio di tutti i collegamenti e la tenuta del prodotto dopo i primi 50 km e in seguito regolarmente. Gli accessori montati possono modificare la maneggevolezza e la stabilità del veicolo.



SW-MOTECH GmbH & Co. KG
Ernteweg 7-10
35282 Rauschenberg
Germania



info@sw-motech.com
www.sw-motech.com



Consultare i simboli e il loro significato nella sezione MONTAGGIO. Se nella sezione montaggio compare la sigla OEM, è necessario rispettare e applicare le specifiche del produttore del veicolo.



Per qualsiasi domanda, non esitare a contattare il nostro servizio clienti o i nostri distributori. Il nostro numero di telefono e l'elenco dei nostri distributori sono disponibili nel nostro shop online all'indirizzo:

www.sw-motech.com



Usare un frenafiletto: indica che la filettatura deve essere rivestita con un frenafiletto liquido. H (ALTA): alta resistenza; M (MEDIA): media resistenza; L (BASSO): bassa resistenza.



Serraggio / rispetto delle specifiche sulla coppia di serraggio: indica la coppia di serraggio di una parte specificata da SW-MOTECH o dal produttore del veicolo (OEM).

ELENCO DELLE PARTI - LEGGI E CONSERVA LE ISTRUZIONI DI MONTAGGIO!

1

1



HTA.06.932.901.01.11

 1/1

2



HTA.00.152.080.35

 3/3

3



HTA.00.152.081.00

 1/1

4



M6 x 20; DIN 6912

SC.ST.06.020.01.6912.088

 1/1

5



M6 x 20; DIN 7991

SC.ST.06.020.48.7991.109

 2/2

2

6



M8 x 25; DIN 6912

SC.ST.08.025.02.6912.088

 2/2

7



ø 8,4; DIN 125

US.ST.084.02.125

 2/2

1

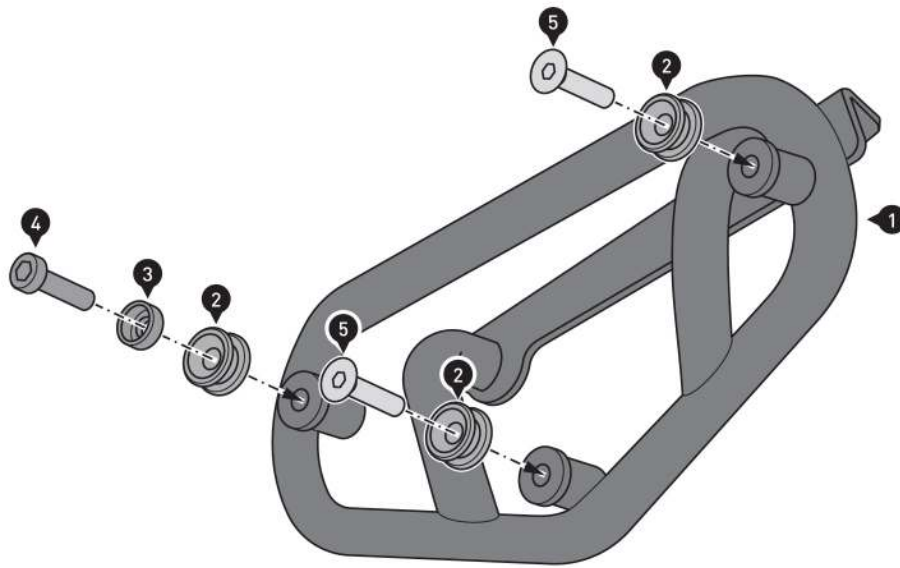

⚠AVVERTENZA: indossare sempre le protezioni per gli occhi e per le mani!
⚠AVVERTENZA: utilizzare sempre strumenti adeguati!

Avvitare le parti da [2] a [5] al telaio laterale (1).
⚠AVVERTENZA: usare un frenafilietti liquido!
 Serrare le viti come specificato



M 8 Nm



M 8 Nm

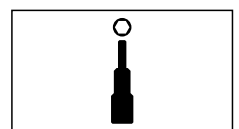
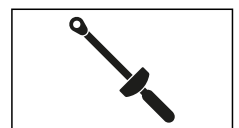
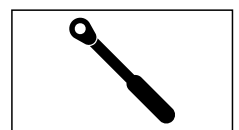

2

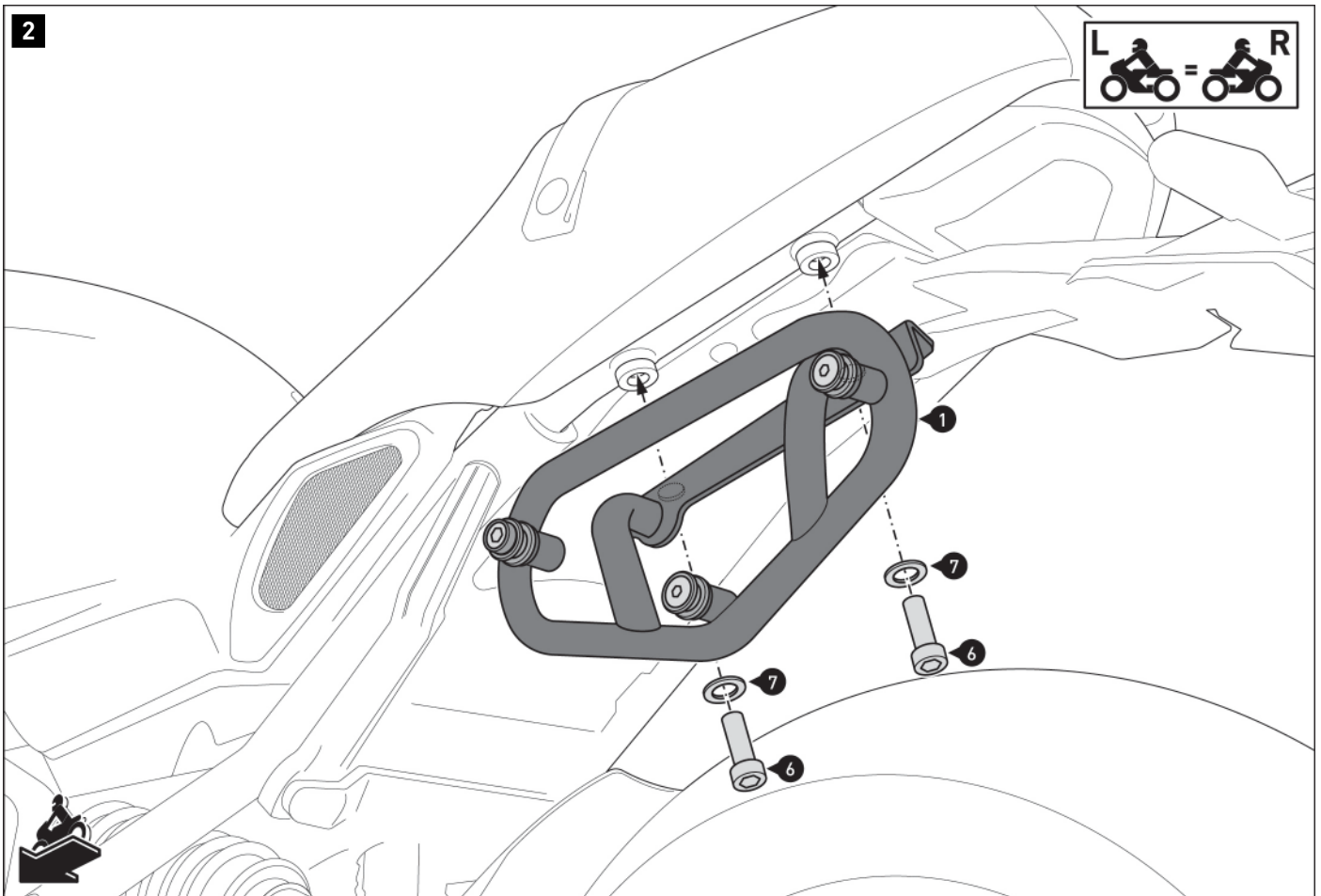

Avvitare il telaio laterale (1) alla parte posteriore del veicolo.
⚠AVVERTENZA: usare un frenafidetti liquido!
 Serrare le viti come indicato.

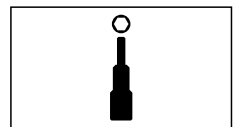
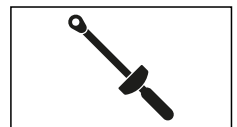

AVVERTENZE SPECIFICHE DEL PRODOTTO

⚠ NOTA :Rispettare le normative specifiche del paese per l'immatricolazione/l'uso del veicolo o le normative TÜV applicabili. Dopo il montaggio, far inserire le parti soggette a omologazione nei documenti del veicolo dal proprio centro di test.

Numero di articolo: HTA.06.932.11000

Revisione: 00 · Data: 12 - 2022

Telaio portaborse SLC destro

 ~ 0.5 h.

 FACILE      DIFFICILE

ITALIANO - Grazie per aver scelto questo prodotto premium di SW-MOTECH. Per ulteriori informazioni (ad esempio per la compatibilità con i vari modelli), è possibile visitare il nostro shop online. I documenti necessari (ad esempio il permesso operativo generale) sono disponibili per il download.

Si prega di leggere attentamente le avvertenze di sicurezza e le istruzioni per il montaggio prima di montare e utilizzare il prodotto, al fine di evitare eventuali lesioni e danni. Conserva queste istruzioni per il montaggio come riferimento futuro.

Questo prodotto è stato sviluppato per veicoli in condizioni di fabbrica. La compatibilità con gli accessori originali o di altri produttori non può essere garantita.

Queste istruzioni per il montaggio sono state redatte in base alle nostre conoscenze attuali. Non sussistono pretese di correttezza giuridiche. Salvo errori ed omissioni. Ci riserviamo il diritto di apportare modifiche tecniche e di design. Copyright SW-MOTECH.

SIMBOLO DI SICUREZZA

 Questo simbolo di avvertenza è usato nelle presenti istruzioni di montaggio per segnalare pericoli mortali, rischio di lesioni o altri pericoli. Le parole "PERICOLO", "AVVERTENZA" o "ATTENZIONE" sono utilizzate con questo simbolo di avvertenza per trasmettere importanti istruzioni di sicurezza e informazioni relative al montaggio e all'uso di questo prodotto. Queste parole, utilizzate insieme al simbolo di avvertenza, significano:

 **PERICOLO:** indica una situazione di pericolo che, se non evitata, può causare morte o lesioni gravi!

 **AVVERTENZA:** indica una situazione di pericolo che, se non evitata, può causare morte o lesioni gravi!

 **ATTENZIONE:** indica una situazione di pericolo che, se non evitata, può provocare lesioni lievi o di entità moderata!

 **AVVISO:** indica informazioni importanti che non riguardano il rischio di morte o di lesioni (riguardano unicamente il rischio di danni materiali)!

INFORMAZIONI GENERALI

 **AVVERTENZA:** il montaggio e/o la manutenzione di questo prodotto richiedono competenze tecniche avanzate, strumenti adeguati e una buona conoscenza dell'uso e delle caratteristiche della strumentazione di montaggio. Per la vostra sicurezza, SW-MOTECH raccomanda di far eseguire il montaggio e/o la manutenzione presso un'officina specializzata e certificata.

 **AVVERTENZA:** se si decide di installare questo prodotto in autonomia, leggere attentamente le istruzioni di montaggio prima del montaggio e dell'uso e seguirle attentamente per evitare lesioni gravi o mortali. Durante il montaggio e l'uso, seguire anche tutte le istruzioni pertinenti contenute nel manuale del veicolo. SE NON SI COMPRENDONO TALI ISTRUZIONI, ANCHE SOLO IN PARTE, O SE SONO NECESSARI CHIARIMENTI, NON CERCARE DI MONTARE IL PRODOTTO IN AUTONOMIA, SENZA CHIEDERE IL SUPPORTO DI SW-MOTECH!

PREPARAZIONE: leggere attentamente le istruzioni per il montaggio e assicurarsi che siano disponibili tutti i componenti contenuti nella lista.

 **ATTENZIONE:** assicurarsi che il veicolo sia perfettamente fermo. Spegner il motore e togliere la chiave. Se necessario, lasciar raffreddare il motore/scarico. Scollegare la batteria quando si interviene sull'impianto elettrico. Usare esclusivamente strumenti idonei e indossare sempre occhiali e guanti protettivi durante le operazioni di montaggio e manutenzione. Chiedere aiuto a una seconda persona durante le fasi di montaggio e manutenzione.

MONTAGGIO: tutti i componenti e i collegamenti rimossi dal veicolo devono essere reinstallati secondo le specifiche del produttore del veicolo o sostituiti con componenti e attrezzatura forniti da SW-MOTECH.

 **AVVERTENZA:** fissare tutte le filettature con frenafili liquido a media resistenza, se non diversamente specificato.

 **PERICOLO:** le coppie di serraggio non definite da SW-MOTECH devono essere richieste al costruttore del veicolo o a un'officina certificata.

CONTROLLO DI FUNZIONALITÀ: dopo il montaggio, accertarsi che non ci siano parti mobili bloccate e che il funzionamento del veicolo non sia disturbato. I cavi e i tubi flessibili non devono essere danneggiati e/o schiacciati.

 **AVVERTENZA:** eseguire un controllo completo delle funzioni prima di mettersi alla guida. Controllare la coppia di serraggio di tutti i collegamenti e la tenuta del prodotto dopo i primi 50 km e in seguito regolarmente. Gli accessori montati possono modificare la maneggevolezza e la stabilità del veicolo.



SW-MOTECH GmbH & Co. KG
Ernteweg 7-10
35282 Rauschenberg
Germania



✉ info@sw-motech.com
🌐 www.sw-motech.com



Consultare i simboli e il loro significato nella sezione MONTAGGIO. Se nella sezione montaggio compare la sigla OEM, è necessario rispettare e applicare le specifiche del produttore del veicolo.



Per qualsiasi domanda, non esitare a contattare il nostro servizio clienti o i nostri distributori. Il nostro numero di telefono e l'elenco dei nostri distributori sono disponibili nel nostro shop online all'indirizzo:
www.sw-motech.com



Usare un frenafiletto: indica che la filettatura deve essere rivestita con un frenafiletto liquido. H (ALTA): alta resistenza; M (MEDIA): media resistenza; L (BASSO): bassa resistenza.



Serraggio / rispetto delle specifiche sulla coppia di serraggio: indica la coppia di serraggio di una parte specificata da SW-MOTECH o dal produttore del veicolo (OEM).

ELENCO DELLE PARTI - LEGGI E CONSERVA LE ISTRUZIONI DI MONTAGGIO!

1

1



HTA.06.932.901.01.11

 1/1

2



HTA.00.152.080.35

 3/3

3



HTA.00.152.081.00

 1/1

4



M6 x 20; DIN 6912

SC.ST.06.020.01.6912.088

 1/1

5



M6 x 20; DIN 7991

SC.ST.06.020.48.7991.109

 2/2

2

6



M8 x 25; DIN 6912

SC.ST.08.025.02.6912.088

 2/2

7



ø 8,4; DIN 125

US.ST.084.02.125

 2/2

1

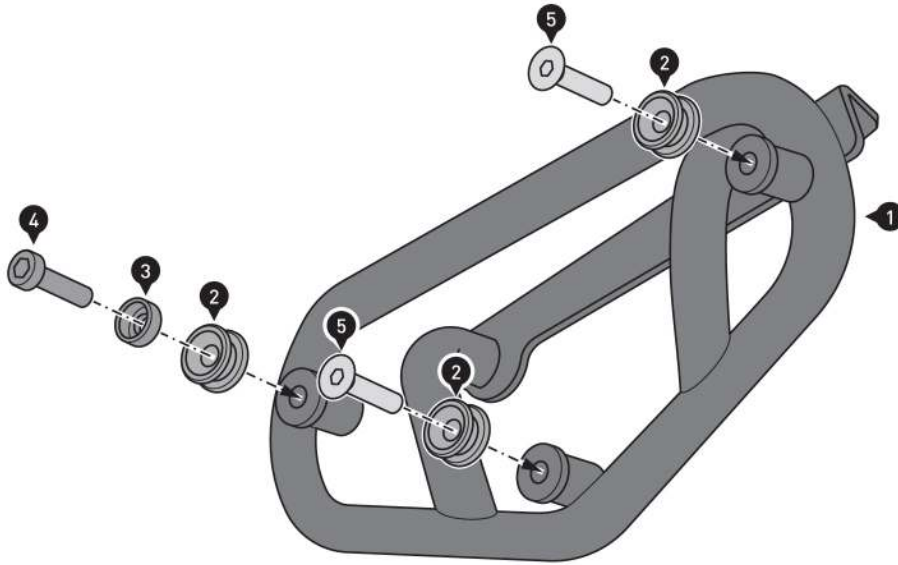

⚠AVVERTENZA: indossare sempre le protezioni per gli occhi e per le mani!
⚠AVVERTENZA: utilizzare sempre strumenti adeguati!

Avvitare le parti da [2] a [5] al telaio laterale (1).
⚠AVVERTENZA: usare un frenafilietti liquido!
 Serrare le viti come specificato



M 8 Nm



M 8 Nm

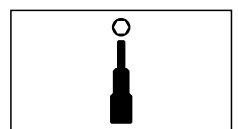
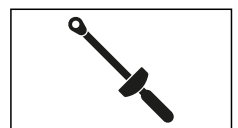
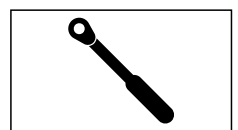

2

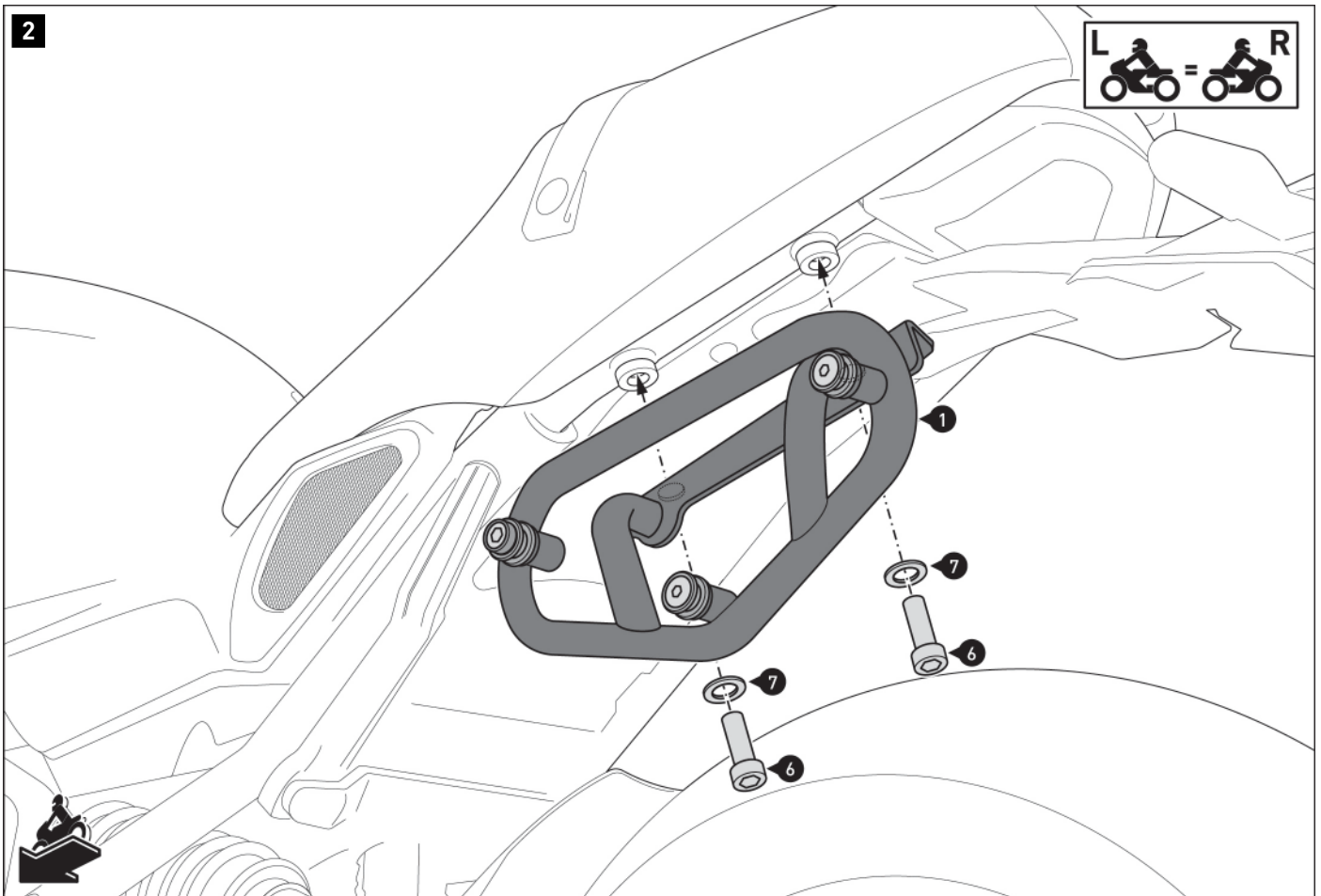

Avvitare il telaio laterale (1) alla parte posteriore del veicolo.
⚠AVVERTENZA: usare un frenafidetti liquido!
 Serrare le viti come indicato.

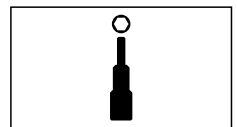
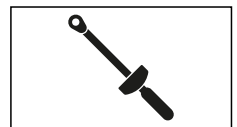

AVVERTENZE SPECIFICHE DEL PRODOTTO

⚠ NOTA :Rispettare le normative specifiche del paese per l'immatricolazione/l'uso del veicolo o le normative TÜV applicabili. Dopo il montaggio, far inserire le parti soggette a omologazione nei documenti del veicolo dal proprio centro di test.

Art.-Nr. / Item No.: **siehe Stückliste / see parts list**

Revision: **00** · Datum / Date: **09 - 2017**

URBAN ABS Seitenkoffer

URBAN ABS side case

DEUTSCH - Vielen Dank, dass Sie sich für dieses Premium-Produkt von SW-MOTECH entschieden haben. Bitte besuchen Sie unseren Webshop für weitere Informationen wie Modellzuweisungen und PDF-Anbauanleitung. Erforderliche Dokumente (z. B. ABE) stehen als Download zur Verfügung.

Die Montage und / oder Wartung dieses Produkts erfordert ein gutes technisches Verständnis! Zu Ihrer eigenen Sicherheit empfiehlt SW-MOTECH, die Montage und / oder Wartung durch eine Fachwerkstatt durchführen zu lassen! SW-MOTECH übernimmt keine Haftung für Schäden, die durch eine unsachgemäße Montage und / oder Wartung verursacht wurden! Beachten Sie alle in der Anbauanleitung angegebenen Hinweise und die für die Montage relevanten Informationen im Fahrzeughandbuch. Nichtbeachtung kann zu Schäden am Fahrzeug bzw. zur Gefährdung des Fahrers führen! Diese Anbauanleitung ist nach unserem derzeitigen Kenntnisstand verfasst worden. Rechtliche Ansprüche auf Richtigkeit bestehen nicht.

Dieses Produkt wurde für Fahrzeuge im Werkzustand entwickelt. Die Kompatibilität mit Original-Zubehörteilen bzw. den Zubehörteilen anderer Hersteller kann nicht gewährleistet werden. Stellen Sie des Weiteren VOR Montage dieses Produkts sicher, dass sich alle beweglichen Teile (z. B. die Kette) im ursprünglichen Wartungszustand befinden. Montiertes Zubehör kann das Fahrverhalten und/oder die Stabilität Ihres Fahrzeugs verändern.

ALLGEMEINE HINWEISE

Beachten Sie die landesspezifischen Vorschriften für Zulassung / Betrieb Ihres Fahrzeugs bzw. anwendbare TÜV-Vorschriften. Lassen Sie eintragungspflichtige Teile nach Montage durch Ihre Prüfstelle in die Fahrzeugpapiere eintragen.

VORBEREITUNG: Lesen Sie die Anbauanleitung aufmerksam und stellen Sie sicher, dass alle Teile der Stückliste vorhanden sind. Achten Sie darauf, dass Ihr Fahrzeug sicher steht und nicht umfallen kann. Schalten Sie den Motor ab und ziehen Sie den Zündschlüssel. Lassen Sie ggf. den Motor / Auspuff abkühlen. Klemmen Sie bei Arbeiten an der Elektrik die Fahrzeugbatterie ab. Verwenden Sie geeignetes Werkzeug. Lassen Sie sich von einer zweiten Person helfen.

FUNKTIONSKONTROLLE: Da es sich um ein universelles Produkt handelt, stellen Sie unbedingt VOR der ersten Nutzung sicher, dass sich das Produkt ohne Probleme und sachgerecht an Ihrem Fahrzeugtyp befestigen und verwenden lässt. Achten Sie nach der Befestigung auf die uneingeschränkte Freigängigkeit und einwandfreie Funktion sämtlicher Fahrzeugteile. Leuchtmittel wie Rücklicht und Blinker dürfen nicht in ihrer Funktion eingeschränkt werden. Kabel, Züge und Schläuche dürfen nicht scheuern und/oder geklemmt werden. Führen Sie vor Fahrtbeginn eine umfassende Funktionskontrolle durch.

PRODUKTSPEZIFISCHE HINWEISE

ACHTUNG: Das Fahr-/Bremsverhalten des Motorrads verändert sich nach Befestigung dieses Produkts merklich!

ACHTUNG: Je nach Ort der Befestigung kann die Kurven- und Bodenfreiheit durch dieses Produkt eingeschränkt werden!

ACHTUNG: Überprüfen Sie vor Fahrtbeginn und bei jeder Rast (alle 200 km) den ordnungsgemäßen Sitz des Produkts!

Maximale Zuladung	Höchstgeschwindigkeit
 5 KG (11 lbs) pro Koffer	 130 km/h (80 mph)

ACHTUNG: Es gilt die vom Fahrzeughersteller genannte maximale Zuladung des Fahrzeugs!

ACHTUNG 
NICHT FÜR DEN OFFROAD-EINSATZ GEEIGNET!

ENGLISH - Thank you for choosing this premium product from SW-MOTECH. Please visit our webshop for additional information, such as application charts and PDF mounting instructions. Any other documents that may be required (e.g. ABE certifications), are also available for download at our webshop.

Installation and / or maintenance of this product require good technical understanding! For your own safety SW-MOTECH recommends having installation and / or servicing carried out by a specialist workshop! SW-MOTECH assumes no liability for damage caused by improper installation and / or maintenance work! Carefully follow all the directions given in the mounting instructions and pay attention to all relevant information in the vehicle manual during assembly. Nonconformance can lead to vehicle damage or even endanger the driver! These mounting instructions are written based on our current state of knowledge. Legal requirements for accuracy do not exist.

This product was developed for vehicles in their factory setting. Compatibility with original accessory parts or other manufacturers' accessory parts is not guaranteed. Furthermore, BEFORE installing this product, make sure that all moving parts (e.g. the chain) are in the original state of maintenance. Installed accessories can change the driving behaviour and / or stability of your vehicle.

GENERAL INFORMATION

Observe the country-specific regulations concerning vehicle registration / operation as well as TÜV regulations if applicable. If required, register installed parts in the vehicle documents through an appropriate inspection authority.

PREPARATION: Read the mounting instructions carefully and make sure that all items of the parts list are included. Make sure that your vehicle is parked safely and cannot fall over. Turn off the engine and remove the ignition key. Let the motor / exhaust cool off if necessary. Disconnect the vehicle battery when working on the electrical system. Use appropriate tools. Have another person to help you.

FUNCTION CHECK: This is a universal product. For this reason make sure BEFORE the first use, that the product can be fixed properly and used without problems with your vehicle type. After fixation also make sure that no moving parts are obstructed and the function of the vehicle is not hindered in any way. Lamps as taillight and turn signals must not be limited in their function. Cables and hoses must not rub and/or be pinched. Before starting to ride, perform a comprehensive check of all functions.

PRODUCT SPECIFIC INFORMATION

ATTENTION: Riding with this product may affect the motorcycles driving and braking performance!

ATTENTION: Depending on the location of fixation, cornering and ground clearance can be reduced by using this product!

ATTENTION: Before riding and at each stop (every 200 km) check proper fixation of the product!

Maximum Load	Maximum Speed
 5 KG (11 lbs) per case	 130 km/h (80 mph)

ATTENTION: The maximum vehicle load specified by the manufacturer must not be exceeded!

ATTENTION 
NOT FOR OFFROAD-USE!

Konfektionierung durch / Packed by:

Datum der Konfektionierung / Date of packaging:



SW-MOTECH GmbH & Co. KG
 Ernteweg 8/10
 35282 Rauschenberg
 Germany

Tel. / phone + 49 (0)6425 / 8168 - 050
 Fax / fax + 49 (0)6425 / 8168 - 10
info@sw-motech.com
www.sw-motech.com

STÜCKLISTE / PARTS LIST

Schritt Step	Nr. No.	Art.-Nr. / Bezeichnung * Item No. / Description *	Artikel	Part	Anzahl ** Quantity **	N-m ***
BC.HTA.00.677.10000L/B URBAN ABS Seitenkoffer links URBAN ABS side case left						
1	(1)	BC.HTA.00.677.10000L/B	URBAN ABS Seitenkoffer links	URBAN ABS Side Case left	1 /1	
2	(2)	BC.LOC.00.001.10200/B	Motorradaschen-Schloss	Lock for Motorcycle Luggage	1 /1	
3	(3)	BC.ZUB.00.064.30000	Wasserdichte Innentasche	Waterproof Inner Bag	1 /1	
BC.HTA.00.677.10000R/B URBAN ABS Seitenkoffer rechts URBAN ABS side case right						
1	(1)	BC.HTA.00.677.10000R/B	URBAN ABS Seitenkoffer rechts	URBAN ABS Side Case right	1 /1	
2	(2)	BC.LOC.00.001.10200/B	Motorradaschen-Schloss	Lock for Motorcycle Luggage	1 /1	
3	(3)	BC.ZUB.00.064.30000	Wasserdichte Innentasche	Waterproof Inner Bag	1 /1	

8.8	Regelgewinde / Coarse Thread Ø	M4	M5	M6	M8	M10	M12
	Stahl FK 8.8 / Steel CL 8.8	N-m	2,8	5,5	9,6	23	46

10.9	Regelgewinde / Coarse Thread Ø	M4	M5	M6	M8	M10	M12
	Stahl FK 10.9 / Steel CL 10.9	N-m	4,1	8,1	14	34	67

* Alle Maßangaben in Millimeter. - ** Der zweite Wert gibt die Gesamtanzahl des jew. Artikels in der Lieferung an.
 *** **Keine Anzugsmomentvorgabe: Verwenden Sie das vom Fzg.-Hersteller definierte Anzugsmoment!** Das Standard-Anzugsmoment der Tabelle kann verwendet werden, wenn es den Fzg.-Hersteller-Vorgaben entspricht.

* All measurements in millimeters. - ** The second number indicates the total quantity of the part in the delivery.
 *** **No torque specifications: Use the torque defined by vehicle manufacturer!** The standard torque in this table can be used as long as it is within the vehicle manufacturer's specifications.

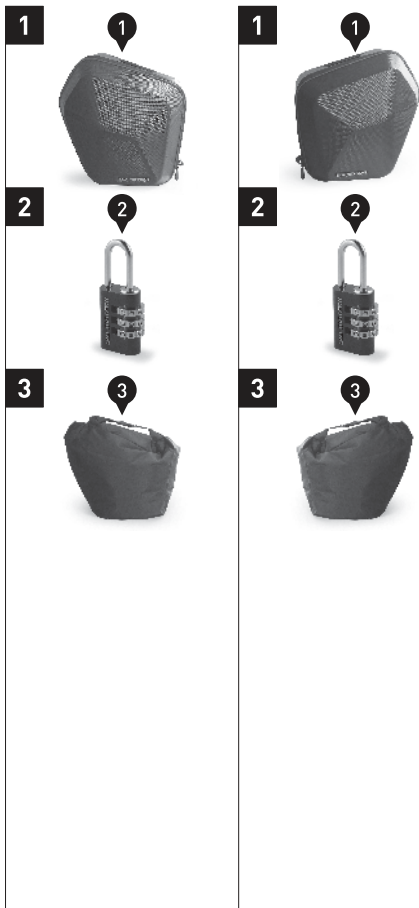

PFLEGE / CARE

Pflege

Verwenden Sie zum Reinigen des Seitenkoffers warme Seifenlauge und ein weiches, sauberes Tuch. Spülen Sie anschließend mit klarem Wasser nach. Verwenden Sie KEINE scharfen Reinigungsmittel, raue Putzwerkzeuge oder einen Hochdruckreiniger! Reinigen Sie den Seitenkoffer unbedingt nach Winterfahrten, um Schäden durch das Salz zu vermeiden.

Schwergängige Reißverschlüsse können mit etwas Talkumpulver wieder gängig gemacht werden.

ACHTUNG: Oberflächenmaterialien können bei längerer und intensiver Sonneneinstrahlung und Umwelteinflüssen (z. B. SMOG, saurer Regen, etc.) Farbveränderungen (Ausbleichen) unterliegen! Dafür übernimmt SW-MOTECH keine Haftung.

Care

To clean the side case, use warm, soapy water and a soft, clean cloth. Rinse with clean water. Do NOT use strong cleaning agents, rough cleaning tools or high pressure washer! Clean the side case after riding in salty conditions, to avoid damage from salt.

Hard to open zippers can be loosened with a small amount of talcum powder.

ATTENTION: Surface materials can experience color changes or fading when exposed to direct sunlight for extended periods of time and by environmental factors (e.g., SMOG, acid rain, etc.)! SW-MOTECH assumes no liability for this.

1



Schieber / Slider

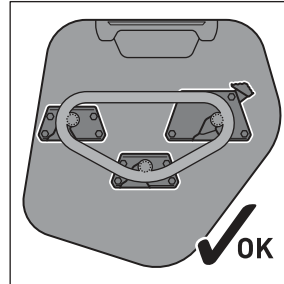
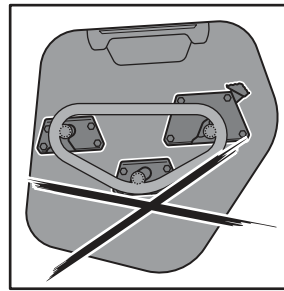

Setzen Sie die drei Arretierungsöffnungen des Seitenkoffers auf die Führungsbolzen des montierten SLC Seitenträgers. Drücken Sie anschließend den Seitenkoffer leicht nach unten, bis dieser fest am SLC Seitenträger sitzt.

ACHTUNG: Achten Sie darauf, dass alle drei Führungsbolzen gleichzeitig einrasten! Achten Sie außerdem auf das deutlich hörbare Einrastgeräusch des Verschlussmechanismus und das die rote Markierung unter dem Schieber nicht sichtbar ist!

Drücken Sie zum Entriegeln den Schieber nach unten.

ACHTUNG: Achten Sie darauf, dass keine Komponenten des Seitenkoffers mit heißen und beweglichen Teilen des Fahrzeugs in Kontakt kommen können! Achten Sie desweiteren darauf, dass alle Komponenten mindestens 5 cm Abstand zu heißen Teilen sowie dem heißen Abgasstrom des Auspuffs haben! Stellen Sie nach der Montage sicher, dass dieser Abstand in jedem Federzustand des Fahrzeugs eingehalten wird!

Place the three locking openings of the side case onto the guide bolts of the mounted SLC side carrier. Then press the side case slightly downward, until it properly rests on the SLC side carrier.

ATTENTION: Make sure that all three guide bolts engage at the same time! Pay attention to the clearly audible snap sound of the locking mechanism and that the red marking under the slider is not visible!

To release press the slider downward.

ATTENTION: All components of the side case must not contact any hot or moving parts of the vehicle! All parts should also remain 5 cm away from hot parts of the vehicle and remain clear of the exhaust stream! After mounting, make sure there are no clearance issues while the suspension is both compressed and extended.

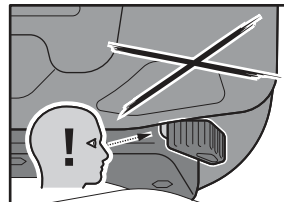

SICHTBARE ROTE MARKIERUNG: NICHT korrekt verriegelt! Verlustgefahr!
VISIBLE RED MARKING: NOT correctly locked! Risk of loss!

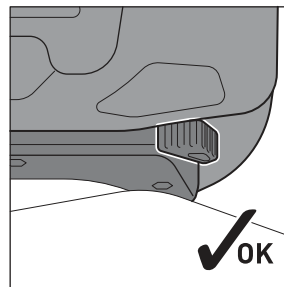

2

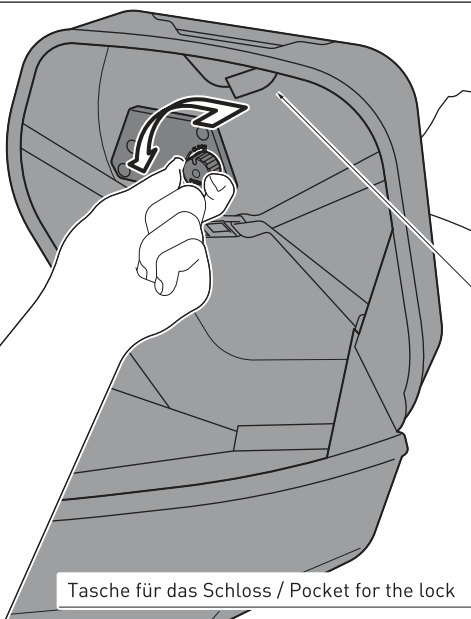

Tasche für das Schloss / Pocket for the lock

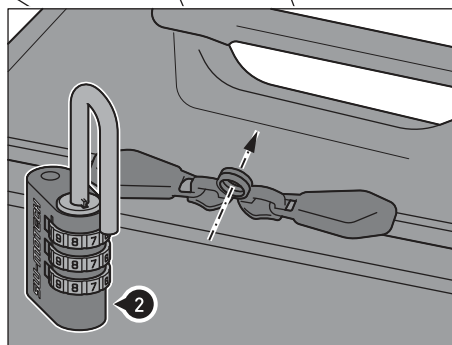
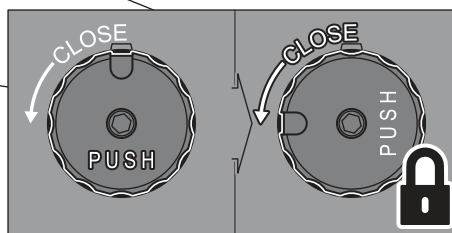

Um den montierten Seitenkoffer (1) gegen Diebstahl zu schützen, muss dieser zunächst geöffnet werden.

Drücken Sie nun den Sicherungsknopf und drehen ihn gemäß der Pfeilmarkierung, bis der Sicherungsknopf einrastet.

Verriegeln Sie nun die Puller des geschlossenen Reißverschluss mit dem beiliegenden Schloss (2).

Wir empfehlen, den Sicherungsknopf während der Fahrt immer in der abgeschlossenen Position zu belassen.

Open the mounted side case (1) to protect it against theft.

Now press the locking button and turn it according to the arrow mark until the locking button engages.

Then lock the closed zipper with the included lock (2)

We recommend leaving the locking button in the closed position during the ride.



Verwenden Sie die beiliegende wasserdichte Innentasche (3), um Ihr Gepäck vor Feuchtigkeit zu schützen.

Use the included waterproof innerbag (3) to protect your luggage from moisture.



Um den Seitenkoffer(1) einfacher beladen zu können, öffnen Sie die Schnallen und Klettverschlüsse der Öffnungsreduzierungen, wie in der Zeichnung gezeigt.

For an easier loading of the side case (1), open the buckles and hook and loop fasteners of the opening reductions, as shown in the drawing.



ACHTUNG: Achten Sie bei beidseitiger Verwendung der Seitenkoffer auf die gleichmäßige Verteilung der Ladung! Stellen Sie sicher, dass die Ladung während der Fahrt gegen Verrutschen gesichert ist!

ACHTUNG: Achten Sie darauf, niemals scharfkantige, spitze oder ähnliche Gegenstände zu verstauen, welche Verletzungen an Personen bzw. Beschädigungen am Fahrzeug/Seitenkoffer verursachen könnten!

ATTENTION: Make sure weight is evenly distributed between the left and right side if you want to use both side cases! Make sure that the loading is secured against shifting during the ride!

ATTENTION: Never store pointy or sharp-edged objects, which could cause injury to persons or damage to the vehicle/side case!

Art.-Nr. / Item No.: **siehe Stückliste / see parts list**

Revision: **00** · Datum / Date: **09 - 2017**

URBAN ABS Seitenkoffer

URBAN ABS side case

DEUTSCH - Vielen Dank, dass Sie sich für dieses Premium-Produkt von SW-MOTECH entschieden haben. Bitte besuchen Sie unseren Webshop für weitere Informationen wie Modellzuweisungen und PDF-Anbauanleitung. Erforderliche Dokumente (z. B. ABE) stehen als Download zur Verfügung.

Die Montage und / oder Wartung dieses Produkts erfordert ein gutes technisches Verständnis! Zu Ihrer eigenen Sicherheit empfiehlt SW-MOTECH, die Montage und / oder Wartung durch eine Fachwerkstatt durchführen zu lassen! SW-MOTECH übernimmt keine Haftung für Schäden, die durch eine unsachgemäße Montage und / oder Wartung verursacht wurden! Beachten Sie alle in der Anbauanleitung angegebenen Hinweise und die für die Montage relevanten Informationen im Fahrzeughandbuch. Nichtbeachtung kann zu Schäden am Fahrzeug bzw. zur Gefährdung des Fahrers führen! Diese Anbauanleitung ist nach unserem derzeitigen Kenntnisstand verfasst worden. Rechtliche Ansprüche auf Richtigkeit bestehen nicht.

Dieses Produkt wurde für Fahrzeuge im Werkzustand entwickelt. Die Kompatibilität mit Original-Zubehörteilen bzw. den Zubehörteilen anderer Hersteller kann nicht gewährleistet werden. Stellen Sie des Weiteren VOR Montage dieses Produkts sicher, dass sich alle beweglichen Teile (z. B. die Kette) im ursprünglichen Wartungszustand befinden. Montiertes Zubehör kann das Fahrverhalten und/oder die Stabilität Ihres Fahrzeugs verändern.

ALLGEMEINE HINWEISE

Beachten Sie die landesspezifischen Vorschriften für Zulassung / Betrieb Ihres Fahrzeugs bzw. anwendbare TÜV-Vorschriften. Lassen Sie eintragungspflichtige Teile nach Montage durch Ihre Prüfstelle in die Fahrzeugpapiere eintragen.

VORBEREITUNG: Lesen Sie die Anbauanleitung aufmerksam und stellen Sie sicher, dass alle Teile der Stückliste vorhanden sind. Achten Sie darauf, dass Ihr Fahrzeug sicher steht und nicht umfallen kann. Schalten Sie den Motor ab und ziehen Sie den Zündschlüssel. Lassen Sie ggf. den Motor / Auspuff abkühlen. Klemmen Sie bei Arbeiten an der Elektrik die Fahrzeugbatterie ab. Verwenden Sie geeignetes Werkzeug. Lassen Sie sich von einer zweiten Person helfen.

FUNKTIONSKONTROLLE: Da es sich um ein universelles Produkt handelt, stellen Sie unbedingt VOR der ersten Nutzung sicher, dass sich das Produkt ohne Probleme und sachgerecht an Ihrem Fahrzeugtyp befestigen und verwenden lässt. Achten Sie nach der Befestigung auf die uneingeschränkte Freigängigkeit und einwandfreie Funktion sämtlicher Fahrzeugteile. Leuchtmittel wie Rücklicht und Blinker dürfen nicht in ihrer Funktion eingeschränkt werden. Kabel, Züge und Schläuche dürfen nicht scheuern und/oder geklemmt werden. Führen Sie vor Fahrtbeginn eine umfassende Funktionskontrolle durch.

PRODUKTSPEZIFISCHE HINWEISE

ACHTUNG: Das Fahr-/Bremsverhalten des Motorrads verändert sich nach Befestigung dieses Produkts merklich!

ACHTUNG: Je nach Ort der Befestigung kann die Kurven- und Bodenfreiheit durch dieses Produkt eingeschränkt werden!

ACHTUNG: Überprüfen Sie vor Fahrtbeginn und bei jeder Rast (alle 200 km) den ordnungsgemäßen Sitz des Produkts!

Maximale Zuladung	Höchstgeschwindigkeit
 5 KG (11 lbs) pro Koffer	 130 km/h (80 mph)

ACHTUNG: Es gilt die vom Fahrzeughersteller genannte maximale Zuladung des Fahrzeugs!

ACHTUNG 

NICHT FÜR DEN OFFROAD-EINSATZ GEEIGNET!

ENGLISH - Thank you for choosing this premium product from SW-MOTECH. Please visit our webshop for additional information, such as application charts and PDF mounting instructions. Any other documents that may be required (e.g. ABE certifications), are also available for download at our webshop.

Installation and / or maintenance of this product require good technical understanding! For your own safety SW-MOTECH recommends having installation and / or servicing carried out by a specialist workshop! SW-MOTECH assumes no liability for damage caused by improper installation and / or maintenance work! Carefully follow all the directions given in the mounting instructions and pay attention to all relevant information in the vehicle manual during assembly. Nonconformance can lead to vehicle damage or even endanger the driver! These mounting instructions are written based on our current state of knowledge. Legal requirements for accuracy do not exist.

This product was developed for vehicles in their factory setting. Compatibility with original accessory parts or other manufacturers' accessory parts is not guaranteed. Furthermore, BEFORE installing this product, make sure that all moving parts (e.g. the chain) are in the original state of maintenance. Installed accessories can change the driving behaviour and / or stability of your vehicle.

GENERAL INFORMATION

Observe the country-specific regulations concerning vehicle registration / operation as well as TÜV regulations if applicable. If required, register installed parts in the vehicle documents through an appropriate inspection authority.

PREPARATION: Read the mounting instructions carefully and make sure that all items of the parts list are included. Make sure that your vehicle is parked safely and cannot fall over. Turn off the engine and remove the ignition key. Let the motor / exhaust cool off if necessary. Disconnect the vehicle battery when working on the electrical system. Use appropriate tools. Have another person to help you.

FUNCTION CHECK: This is a universal product. For this reason make sure BEFORE the first use, that the product can be fixed properly and used without problems with your vehicle type. After fixation also make sure that no moving parts are obstructed and the function of the vehicle is not hindered in any way. Lamps as taillight and turn signals must not be limited in their function. Cables and hoses must not rub and/or be pinched. Before starting to ride, perform a comprehensive check of all functions.

PRODUCT SPECIFIC INFORMATION

ATTENTION: Riding with this product may affect the motorcycles driving and braking performance!

ATTENTION: Depending on the location of fixation, cornering and ground clearance can be reduced by using this product!

ATTENTION: Before riding and at each stop (every 200 km) check proper fixation of the product!

Maximum Load	Maximum Speed
 5 KG (11 lbs) per case	 130 km/h (80 mph)

ATTENTION: The maximum vehicle load specified by the manufacturer must not be exceeded!

ATTENTION 

NOT FOR OFFROAD-USE!

Konfektionierung durch / Packed by:

Datum der Konfektionierung / Date of packaging:



SW-MOTECH GmbH & Co. KG
Ernteweg 8/10
35282 Rauschenberg
Germany

Tel. / phone + 49 (0)6425 / 8168 - 050
Fax / fax + 49 (0)6425 / 8168 - 10
info@sw-motech.com
www.sw-motech.com

1



Schieber / Slider

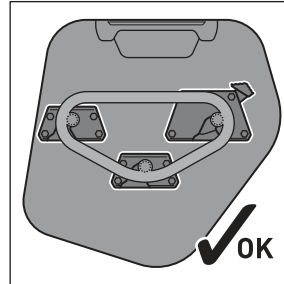
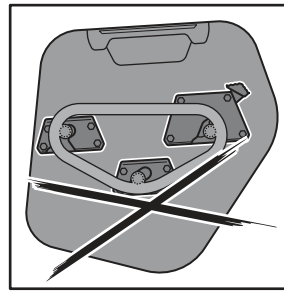

Setzen Sie die drei Arretierungsöffnungen des Seitenkoffers auf die Führungsbolzen des montierten SLC Seitenträgers. Drücken Sie anschließend den Seitenkoffer leicht nach unten, bis dieser fest am SLC Seitenträger sitzt.

ACHTUNG: Achten Sie darauf, dass alle drei Führungsbolzen gleichzeitig einrasten! Achten Sie außerdem auf das deutlich hörbare Einrastgeräusch des Verschlussmechanismus und das die rote Markierung unter dem Schieber nicht sichtbar ist!

Drücken Sie zum Entriegeln den Schieber nach unten.

ACHTUNG: Achten Sie darauf, dass keine Komponenten des Seitenkoffers mit heißen und beweglichen Teilen des Fahrzeugs in Kontakt kommen können! Achten Sie desweiteren darauf, dass alle Komponenten mindestens 5 cm Abstand zu heißen Teilen sowie dem heißen Abgasstrom des Auspuffs haben! Stellen Sie nach der Montage sicher, dass dieser Abstand in jedem Federzustand des Fahrzeugs eingehalten wird!

Place the three locking openings of the side case onto the guide bolts of the mounted SLC side carrier. Then press the side case slightly downward, until it properly rests on the SLC side carrier.

ATTENTION: Make sure that all three guide bolts engage at the same time! Pay attention to the clearly audible snap sound of the locking mechanism and that the red marking under the slider is not visible!

To release press the slider downward.

ATTENTION: All components of the side case must not contact any hot or moving parts of the vehicle! All parts should also remain 5 cm away from hot parts of the vehicle and remain clear of the exhaust stream! After mounting, make sure there are no clearance issues while the suspension is both compressed and extended.

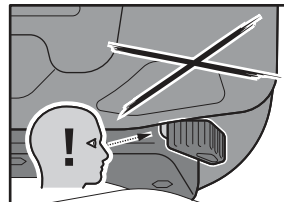

SICHTBARE ROTE MARKIERUNG: NICHT korrekt verriegelt! Verlustgefahr!
VISIBLE RED MARKING: NOT correctly locked! Risk of loss!

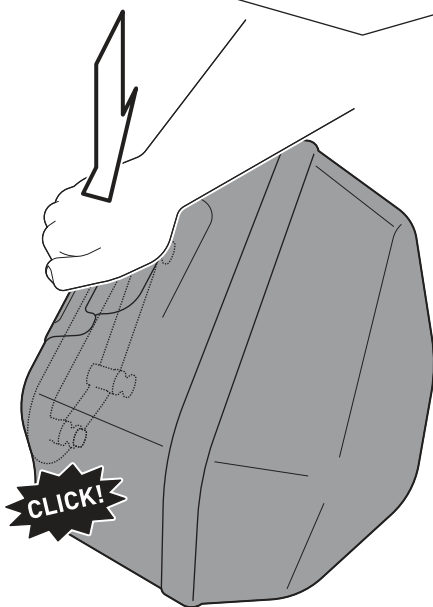
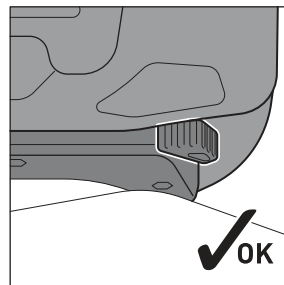

2

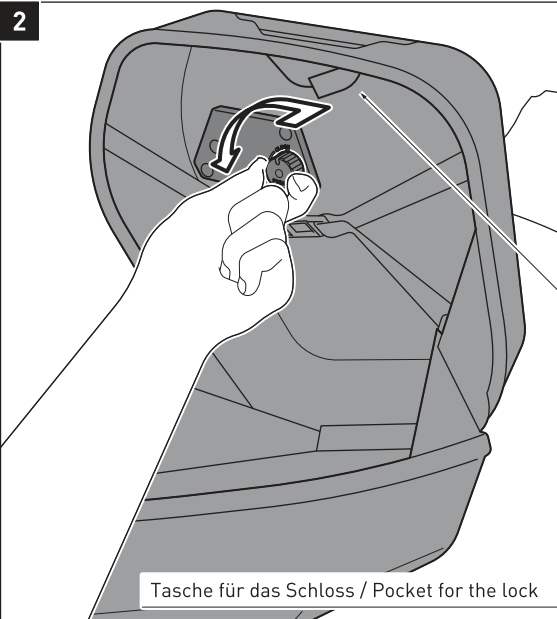

Tasche für das Schloss / Pocket for the lock

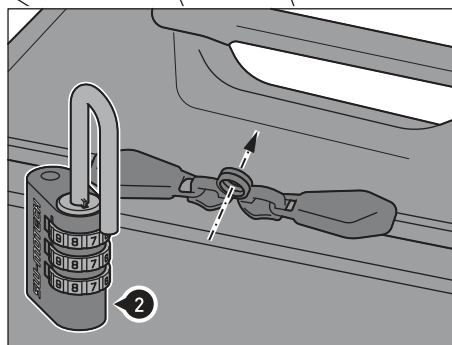
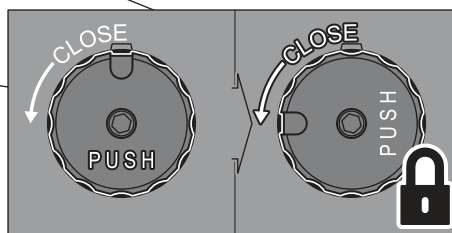

Um den montierten Seitenkoffer (1) gegen Diebstahl zu schützen, muss dieser zunächst geöffnet werden.

Drücken Sie nun den Sicherungsknopf und drehen ihn gemäß der Pfeilmarkierung, bis der Sicherungsknopf einrastet.

Verriegeln Sie nun die Puller des geschlossenen Reißverschlusses mit dem beiliegenden Schloss (2).

Wir empfehlen, den Sicherungsknopf während der Fahrt immer in der abgeschlossenen Position zu belassen.

Open the mounted side case (1) to protect it against theft.

Now press the locking button and turn it according to the arrow mark until the locking button engages.

Then lock the closed zipper with the included lock (2)

We recommend leaving the locking button in the closed position during the ride.



Verwenden Sie die beiliegende wasserdichte Innentasche (3), um Ihr Gepäck vor Feuchtigkeit zu schützen.

Use the included waterproof innerbag (3) to protect your luggage from moisture.



Um den Seitenkoffer(1) einfacher beladen zu können, öffnen Sie die Schnallen und Klettverschlüsse der Öffnungsreduzierungen, wie in der Zeichnung gezeigt.

For an easier loading of the side case (1), open the buckles and hook and loop fasteners of the opening reductions, as shown in the drawing.



ACHTUNG: Achten Sie bei beidseitiger Verwendung der Seitenkoffer auf die gleichmäßige Verteilung der Ladung! Stellen Sie sicher, dass die Ladung während der Fahrt gegen Verrutschen gesichert ist!

ACHTUNG: Achten Sie darauf, niemals scharfkantige, spitze oder ähnliche Gegenstände zu verstauen, welche Verletzungen an Personen bzw. Beschädigungen am Fahrzeug/Seitenkoffer verursachen könnten!

ATTENTION: Make sure weight is evenly distributed between the left and right side if you want to use both side cases! Make sure that the loading is secured against shifting during the ride!

ATTENTION: Never store pointy or sharp-edged objects, which could cause injury to persons or damage to the vehicle/side case!